



**9900A/B/C/CX/AEGIS SERIES
SUMMIT SERIES
Web/SNMP/Modbus Board
(LookUPS)**

OWNER'S / TECHNICAL MANUAL

Preface

The LookUPS Web/SNMP Communications Board is a new TMEIC product designed to replace the NETCOM peripheral for all models in the 9900 series. In addition to the SNMP/Web functionalities of the NETCOM, the LookUPS board also provides Serial and Ethernet MODBUS communication.

The LookUPS board is a UPS peripheral that can be used to monitor UPS operation and notify of critical events via several means of communication, such as e-mail, web, Modbus or SNMP.

For technical support or help configuring the LookUPS board, contact our technical service group.

Phone: 800-887-7830

Fax: 724-778-3146

TABLE OF CONTENTS

1. How To Use This Manual	3
1. 1 Caution For Wirings	3
1. 2 Caution For Use	3
1. 3 Caution For Maintenance	3
1. 4 Caution For Operation	4
2. Overview	5
2. 1 Functions	5
2. 2 Specifications	6
2. 3 Part Name	7
3. Web/SNMP Board Settings	9
4. Web Monitoring Function	10
4. 1 Login	10
4. 1. 1 Operation Screen	11
4. 2 Log-out	Error! Bookmark not defined.
4. 3 View	13
4. 3. 1 UPS Status	13
4. 3. 2 UPS Internal History	17
4. 3. 3 System Information	18
4. 4 Setup	19
4. 4. 1 Sysem	19
4. 4. 2 Date & Time	21
4. 4. 3 IP	22
4. 4. 4 Web	23
4. 4. 5 SNMP	23
4. 4. 6 Email	25
4. 4. 7 Modbus	27
4. 4. 8 Language	28
4. 4. 9 User(administrator)	29
4. 4. 10 User(User)	30
4. 5 Maintenance	31
4. 5. 1 Download	31
4. 5. 2 Firmware Update	32

4. 5. 3 Restart	33
4. 5. 4 Initialize	34
4. 5. 5 System Event log	35
5. Email Notification Function	36
6. SNMP Agent Function	Error! Bookmark not defined.
6. 1 UPS MIB (RFC1628)	37
6. 1. 1 SNMP Get	37
6. 2 SNMP Trap	40
6. 2. 1 SNMP Trap	40
6. 3 Trap Variable-Bindings Details	41
7. Modbus Slave Function	Error! Bookmark not defined.
7. 1 RS-485 connection	49
7. 2 Modbus Device List	50
8. Maintenance Service Address	61

1. HOW TO USE THIS MANUAL

This manual is designed to give the user easy and quick reference to information.

This manual uses notice icons to draw attention to the user important information regarding the safe operation and installation of the LookUPS communication board. The notice icons used in this manual are explained below and should be taken into account and adhered to whenever they appear in the text of this manual.

1. 1 Caution for Wiring

Caution 	<ul style="list-style-type: none">Wiring maintenance and installation should be performed by a professional and qualified service technician. Defects with wiring can result in electric shock, fire, and/or fault in product.
---	--

1. 2 Caution for Use

Caution 	<ul style="list-style-type: none">Do NOT touch, repair, or retrofit LookUPS. Failure to follow this warning may result in electrical shock.
---	---

1. 3 Caution for Maintenance

Caution 	<ul style="list-style-type: none">Only Mitsubishi Electric Power Products, Inc qualified service technicians should perform maintenance on the LookUPS board.
---	---

【Information for Qualified Service Personnel】

Caution 	<ul style="list-style-type: none">Maintenance on the LookUPS should only be performed after fully understanding the contents of this technical manual. Improper procedure can result in electric shock, fire, and/or fault in product.Do NOT touch LookUPS with wet hands. This increases risk of electrical shock.
---	--

1. 4 Caution for Operation

<p>Caution</p> 	<ul style="list-style-type: none">• Operation of the LookUPS should only be performed after fully understanding the contents of this technical manual.• A fault in other connected equipment is not covered under warranty, even if caused by a fault from the LookUPS board.
---	--

<p>Caution</p> 	<ul style="list-style-type: none">• In the case of a fault in the LookUPS board, contact a Mitsubishi Electric Power Products, Inc. qualified service technician. Provide the service technician with a detailed description of the fault.
---	--

2. Overviews

2.1 Functions

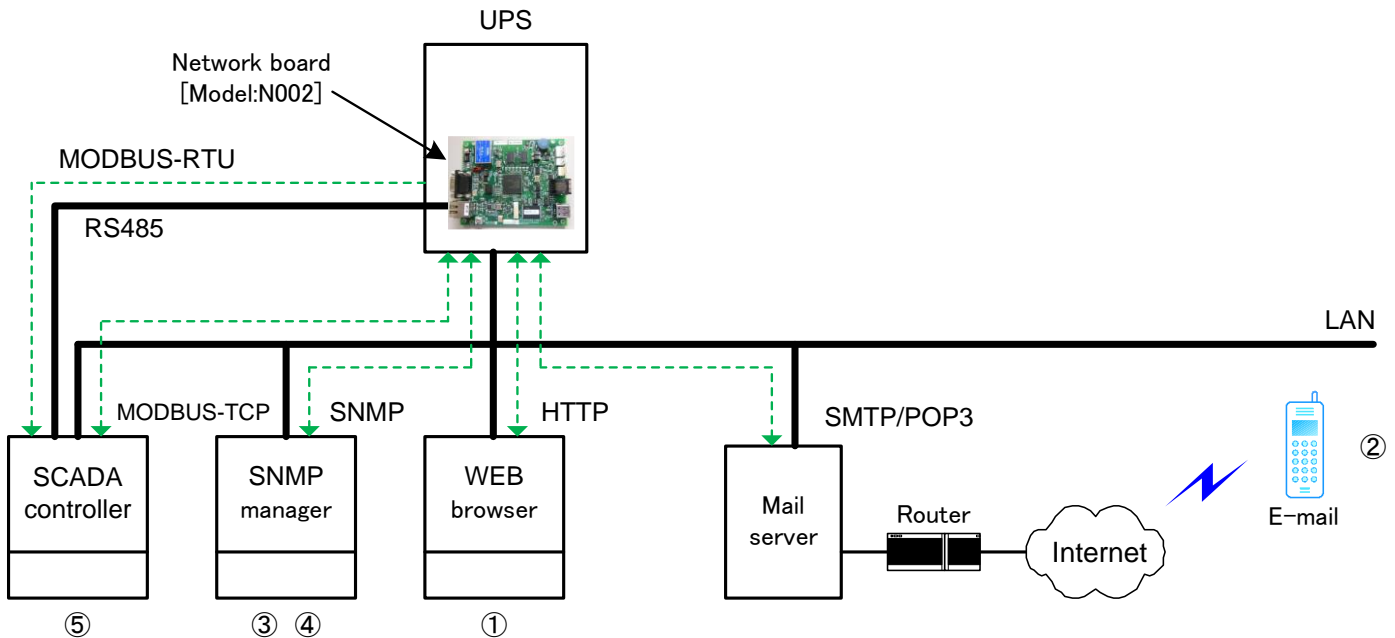

SCADA : Kind of industrial control systems typical stands for Supervisory Control And Data Acquisition
 SNMP : Network Management Protocol typical stands for Simple Network Management Protocol

The LookUPS board offers the following functions:

No.	Item	Function
1	WEB browser	UPS operation can be observed by a generic WEB browser with the built-in WEB server.
2	Automatic e-mail alarm	Designated administrators can receive e-mails when there is a UPS alarms.
3	SNMP agent (Standard UPS MIB)	UPS operation can be observed through a generic SNMP manager with the built-in SNMP agent using standard UPS MIB (RFC1628)
4	SNMP agent (Extended JEMA MIB)	Detailed operation status for the UPS can be observed with the extended JEMA MIB.
5	MODBUS slave	UPS operation can be observed by using the built-in MODBUS slave protocol. MODBUS-TCP (LAN) and MODBUS-RTU (RS485) are available.

2. 2 Specifications

(1) Hardware Specifications

Network Interface	System		10BASE-T / 100BASE-TX (Auto Negotiation)		
	Connector		RJ45		
Serial Interface	COM1	Equipment	UPS		
		System	RS232C (38400bps)		
		Protocol	SEC Protocol, Expanded Command		
		Connector	Molex 4P		
	COM2	Equipment	MODBUS-RTU Master- Equipment	RS232C-RS485 Converter	
		System	RS485 (3600, 4800, 9600, 19200bps)	RS232C (3600,4800,9600,19200bps)	
		Protocol	MODBUS-RTU Slave		
Connector	DSUB 9 Pin male (Inch Thread)				
USB Interface	USB	Equipment	USB Memory Stick		
		System	USB HOST		
		Connector	USB A		
Others	Dimension		D120×W100		
	Weights		100g		
	Power Consumption		No more than 5W		
	Ambient Temperature		32°F(0°C) ~ 122°F(50°C)		
	Relative Humidity		30 ~ 90%Rh (w/o Condensation)		
	Atmosphere		NO corrosive gas, NO inflammable gas, NO oil mist, NO dust		
	Altitude		Lower than 1000m (3281ft)		
	Lifetime		10 years		

Caution Do NOT operate or keep the LookUPS board in an atmosphere with corrosive gas,
 inflammable gas, oil mist, or dust.

(2) Software Specification

Browser	Windows: IE8.0 or later
---------	-------------------------

1. If LookUPS is reset or shut down once powered on again try refreshing the web browser to connect to LookUPS. If refreshing the web browser fails to update the web interface, close and reopen the web browser.
2. Ensure that all proxy server settings are turned off or set to "connect directly to the internet."
3. Your web browser version may affect the display format. If this occurs, try adjusting the font size. Certain operating systems or web browsers may not support full functionality.

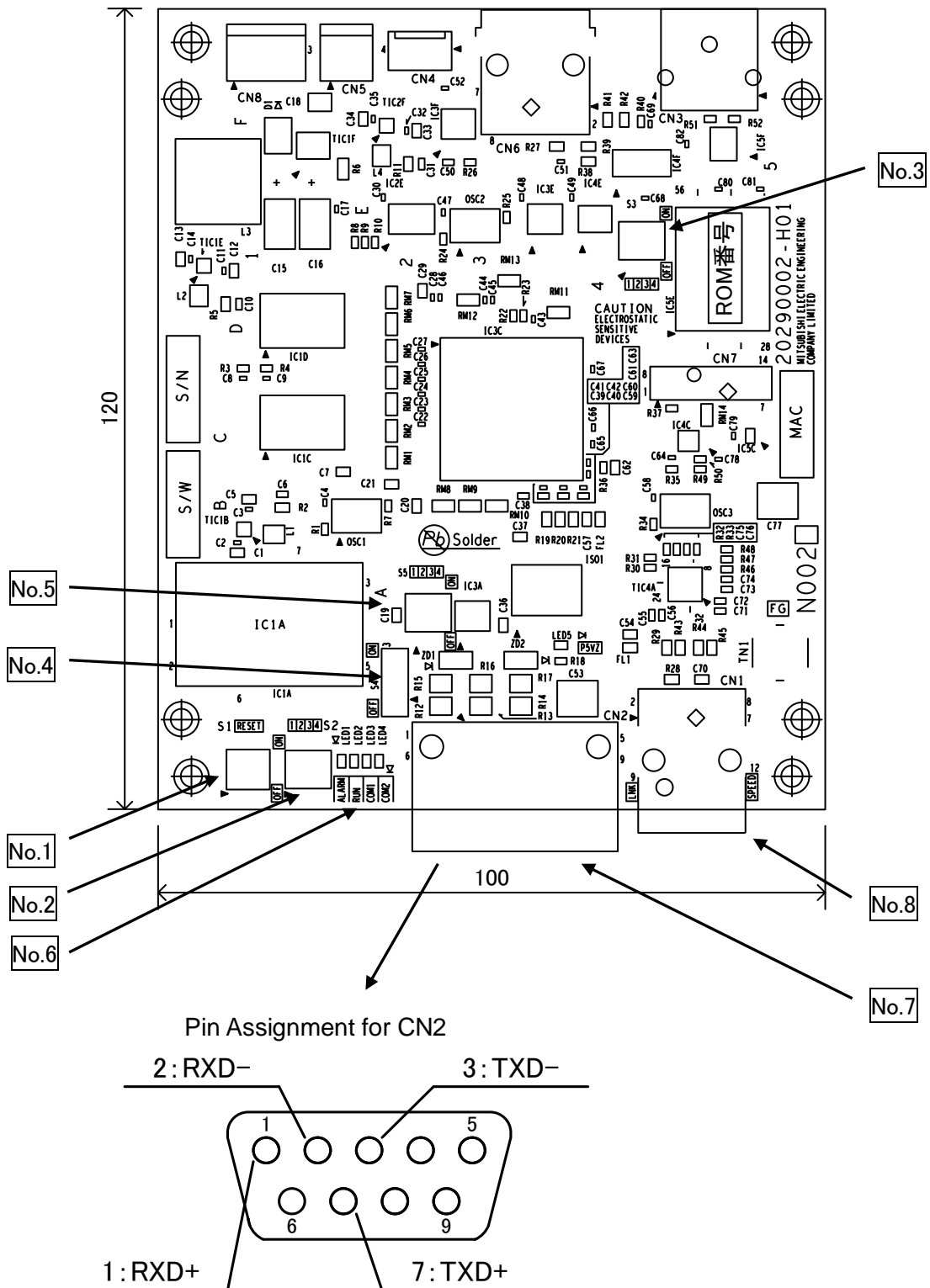
2. 3 Part Name

No.	Symbol	Purpose	Description
1	S1	Reset SW	Reset switch to restart LookUPS
2	S2	Setting SW 1	Not for use
3	S3	Setting SW 2	For repair and retrofit
4	S4	Termination Resistor SW	To switch termination resistor on for RS485
5	S5	Setting SW 3	Dipole switch to change RS232C/RS485 (All OFF for RS232C, All ON for RS485)
6	LED	Status	LookUPS status: [LED1 : ALARM] On: Board Abnormal Off: Board Normal [LED2 : RUN] Blink: Running Normally Off: Power Off or Operation Suspended [LED3 : COM1] On: UPS Communicating Off: UPS Communication Suspended [LED4 : COM2]
7	CN2 [RS485]	MODBUS Slave	D-SUB 9pin connector for RS232C or RS485
8	CN1 [LAN]	Network Interface	LAN connector for Network Interface 10BASE-T / 100BASE-TX (Auto Negotiation)

Caution

- Do NOT insert or remove connectors or power cable on LookUPS while UPS is operating.
- A LAN cable should be connected to CN1 of LookUPS.

3. Web/SNMP Board Settings

Below are the factory default network settings for the LookUPS board:

IP Address: 192.168.10.1

Subnet Mask: 255.255.255.0

Default Gateway: 0.0.0.0

In order to first configure LookUPS for customer use, you must communicate with the board with its factory default settings. Connect your computer to the LookUPS board via a LAN cable (connector CN2 on board) and a compatible web browser. Change your computer's IP settings to connect to LookUPS by opening Control Panel > Network & Internet > Network & Sharing Center > Change Adapter Settings > Properties. Then select properties for the TCP/IPv4. The above IP Address is the address of the LookUPS board, so set your computer to an arbitrary IP Address in the same subnet, such as 192.168.10.7. The LookUPS board's default IP address can then be entered into a web browser. Once connected to the LookUPS board follow the instructions in section 4 of this manual.

If you are unable to communicate with the LookUPS board through the web browser for initial setup, please consult technical support for assistance.

4. Web Monitoring Function

4.1 Login

Once connected to the LookUPS board through the built-in web interface, the screen below will show.

Input the default Username and Password, and then push "Login".

Factory default:

Username: admin
Password: adminpass

When signing on for the first time the user has administrator rights until the LookUPS board is configured otherwise.

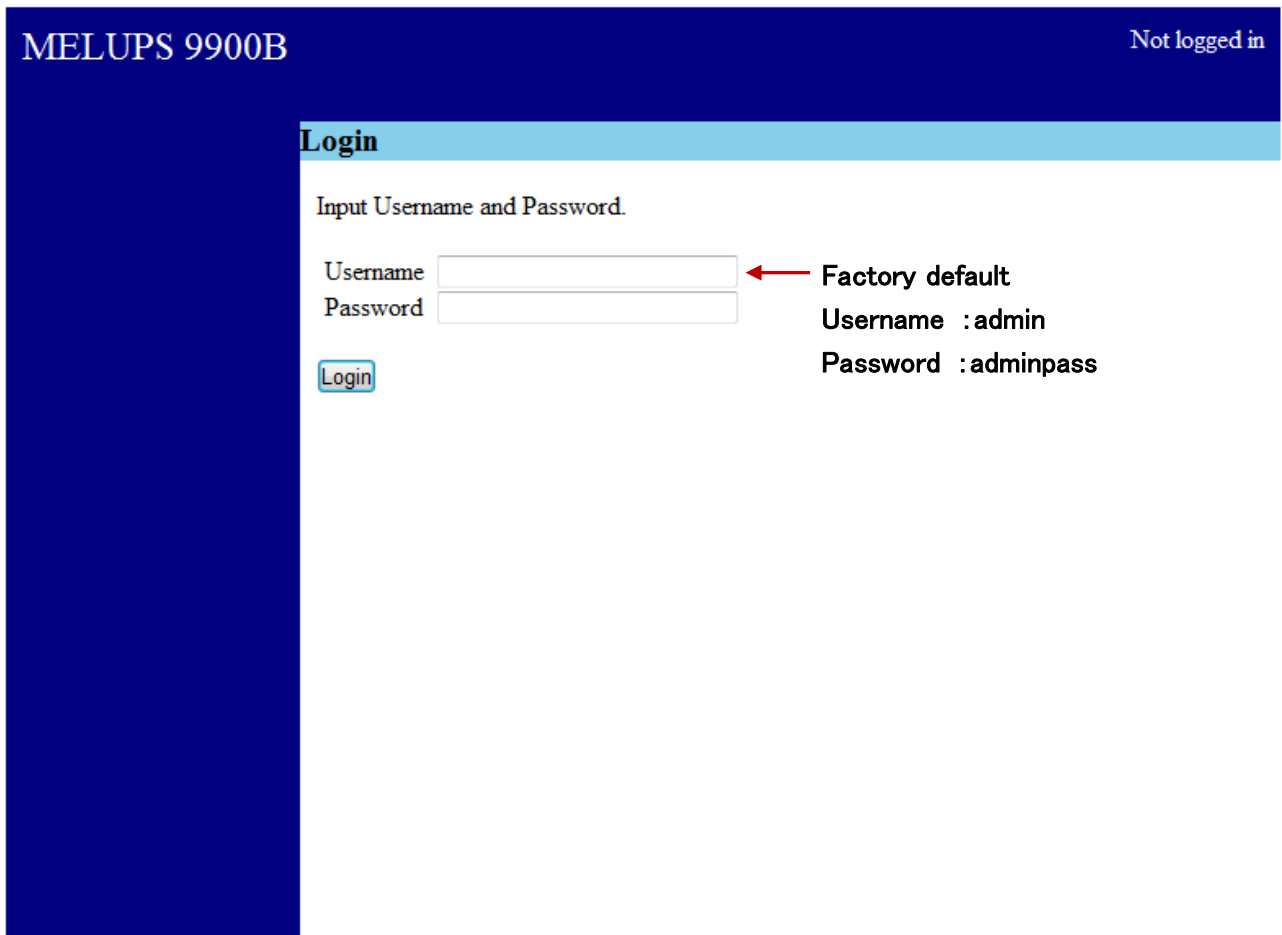

MELUPS 9900B Not logged in

Login

Input Username and Password.

Username ← **Factory default**

Password **Username :admin**

Password :adminpass

4. 1. 1 Operation Screen

The Operation Screen shows an example of the UPS Status screen. This screen is the initial screen shown when logging into the LookUPS board.

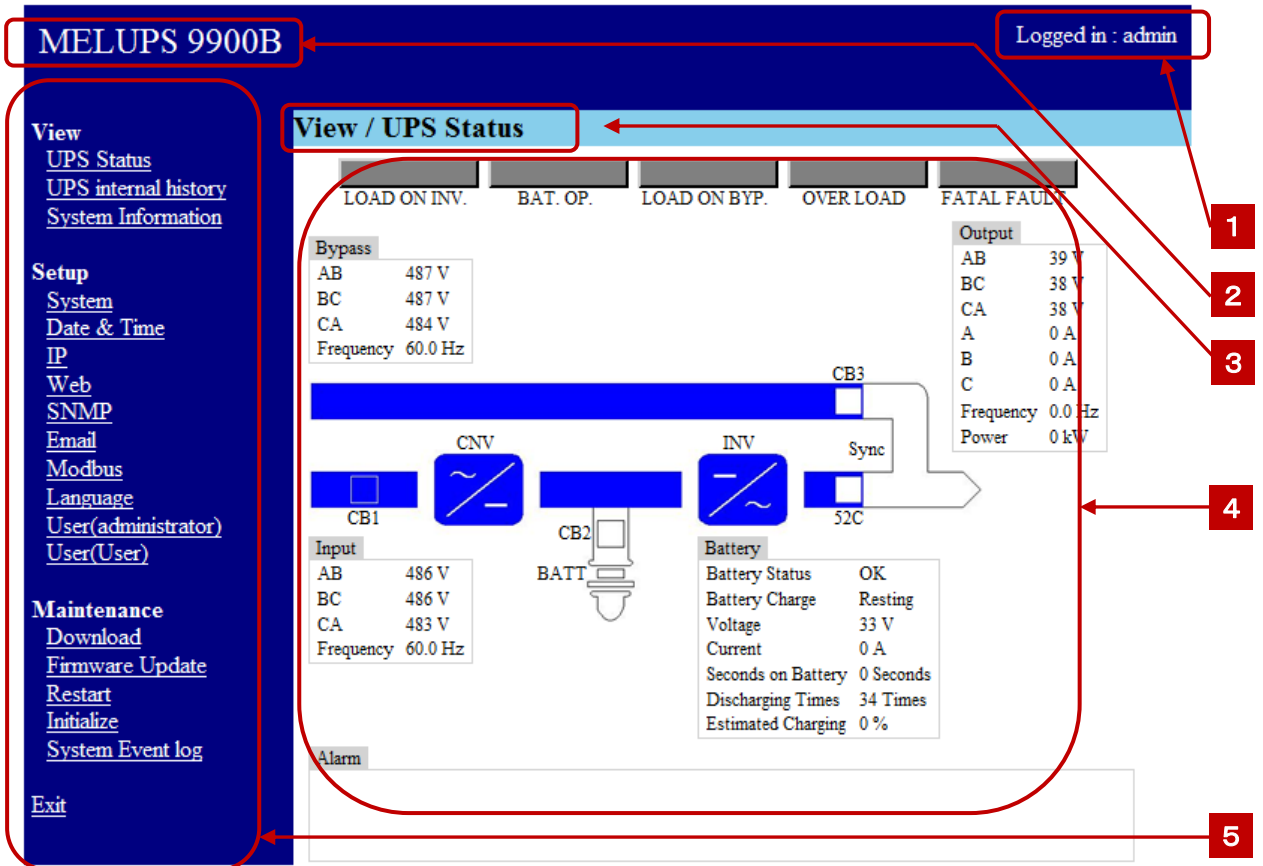

MELUPS 9900B | Logged in : admin

View / UPS Status

LOAD ON INV. | BAT. OP. | LOAD ON BYP. | OVER LOAD | FATAL FAULT

Bypass

AB	487 V
BC	487 V
CA	484 V
Frequency	60.0 Hz

Output

AB	39 V
BC	38 V
CA	38 V
A	0 A
B	0 A
C	0 A
Frequency	0.0 Hz
Power	0 kW

Input

AB	486 V
BC	486 V
CA	483 V
Frequency	60.0 Hz

Battery

Battery Status	OK
Battery Charge	Resting
Voltage	33 V
Current	0 A
Seconds on Battery	0 Seconds
Discharging Times	34 Times
Estimated Charging	0 %

Maintenance

- Download
- Firmware Update
- Restart
- Initialize
- System Event log

Description	
1	User currently logged in
2	UPS Model
3	Menu currently selected
4	Function Screen
5	Function Menu (View, Setup, Maintenance)

4. 2 Log-out

Click "Exit" to log out of the LookUPS board and return to the login screen.

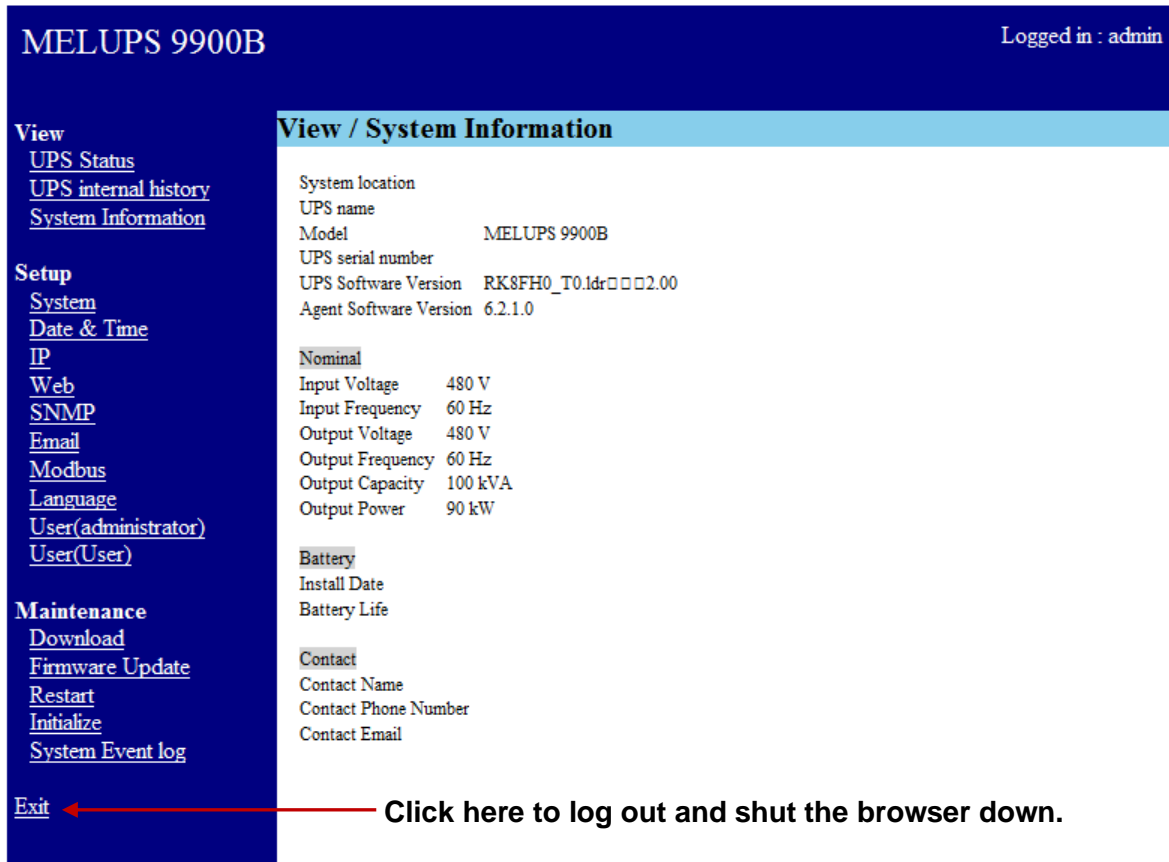

The screenshot shows the MELUPS 9900B web interface. The top header displays "MELUPS 9900B" and "Logged in : admin". A left-hand navigation menu includes sections for "View", "Setup", and "Maintenance", with "Exit" at the bottom. A red arrow points to the "Exit" link. The main content area, titled "View / System Information", displays system details such as location, name, model, serial number, software versions, and nominal specifications (input/output voltage, frequency, capacity, power). It also lists battery and contact information.

View / System Information	
System location	
UPS name	
Model	MELUPS 9900B
UPS serial number	
UPS Software Version	RK8FH0_T0.ldr□□□2.00
Agent Software Version	6.2.1.0
Nominal	
Input Voltage	480 V
Input Frequency	60 Hz
Output Voltage	480 V
Output Frequency	60 Hz
Output Capacity	100 kVA
Output Power	90 kW
Battery	
Install Date	
Battery Life	
Contact	
Contact Name	
Contact Phone Number	
Contact Email	

Note: Closing the browser by clicking on the window doesn't log out of the web interface. An automatic logout will occur after prolonged inactivity.

4. 3 View

4. 3. 1 UPS Status

The UPS Status screen shows the current UPS operating state. Note that the five indicators at the top of the screen are identical to the LED indicators on the front panel of the UPS.

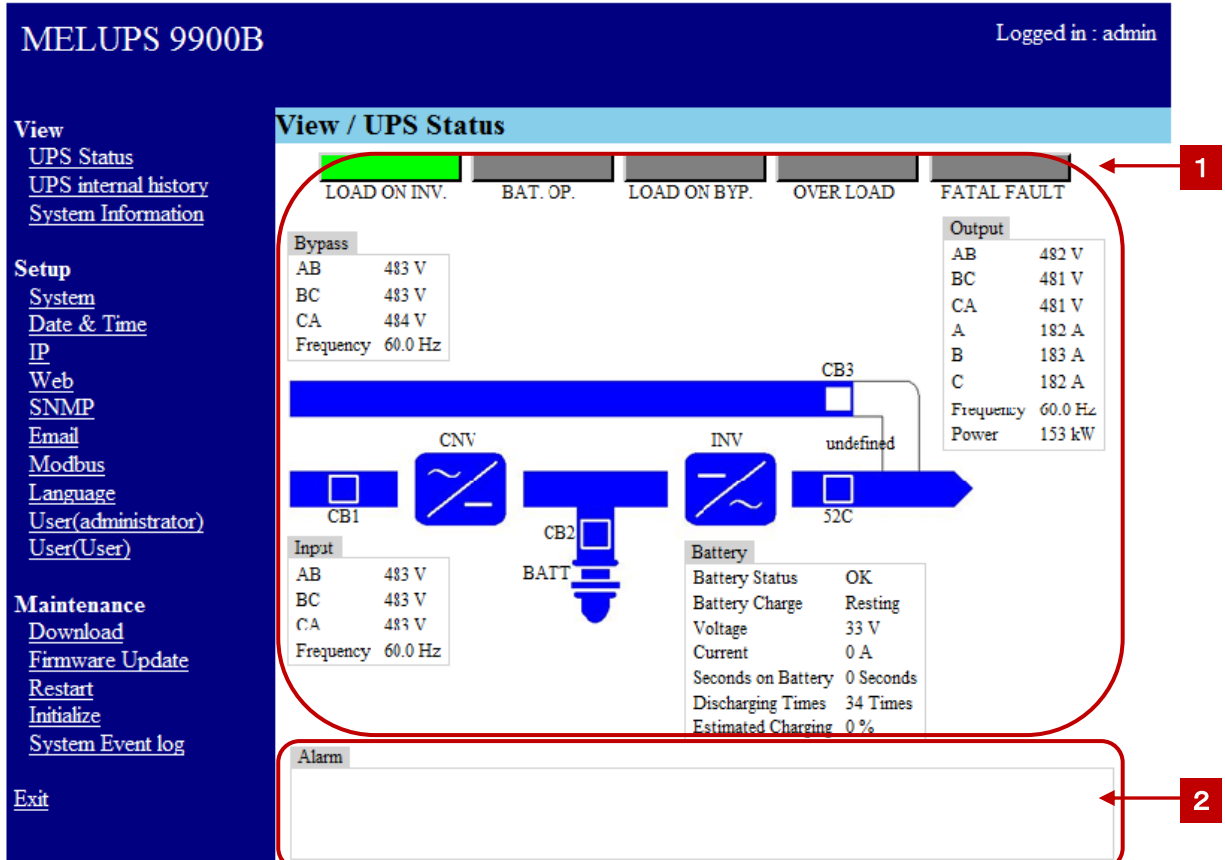

MELUPS 9900B Logged in : admin

View / UPS Status

LOAD ON INV. BAT. OP. LOAD ON BYP. OVER LOAD FATAL FAULT 1

Bypass	
AB	483 V
BC	483 V
CA	484 V
Frequency	60.0 Hz

Output	
AB	482 V
BC	481 V
CA	481 V
A	182 A
B	183 A
C	182 A
Frequency	60.0 Hz
Power	153 kW

Input

AB	483 V
BC	483 V
CA	483 V
Frequency	60.0 Hz

Battery

Battery Status	OK
Battery Charge	Resting
Voltage	33 V
Current	0 A
Seconds on Battery	0 Seconds
Discharging Times	34 Times
Estimated Charging	0.0%

Alarm

2

1 State

The following screenshots show examples of how the web interface will appear under each UPS state.

[LOAD ON INV.]

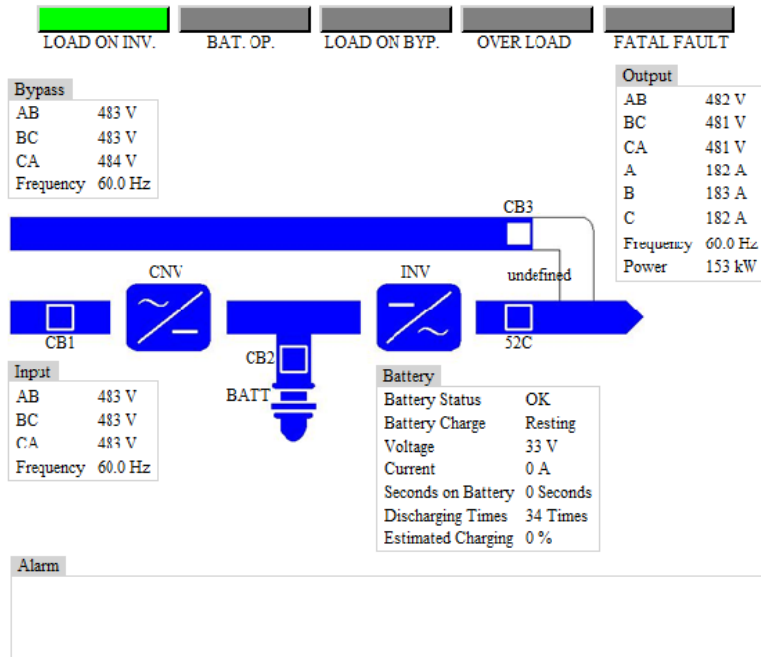

[BAT.OP.]

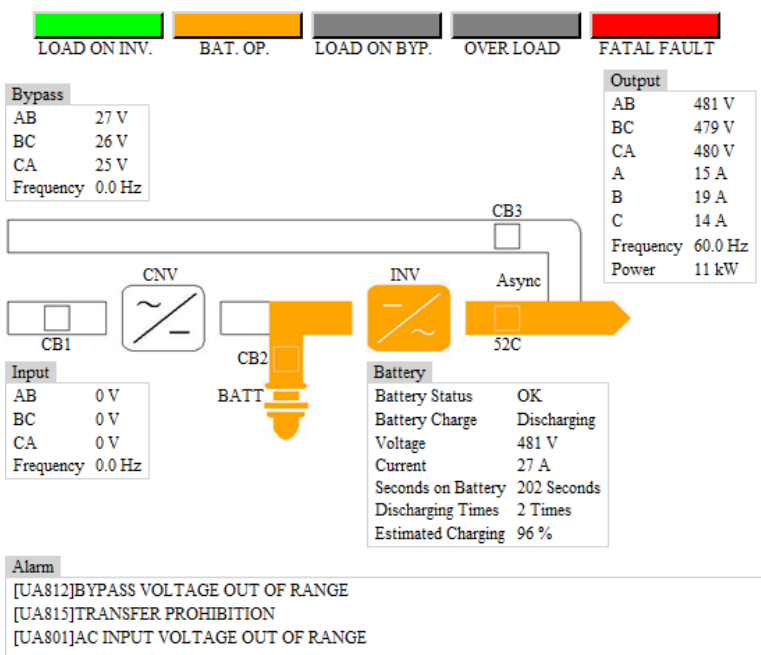

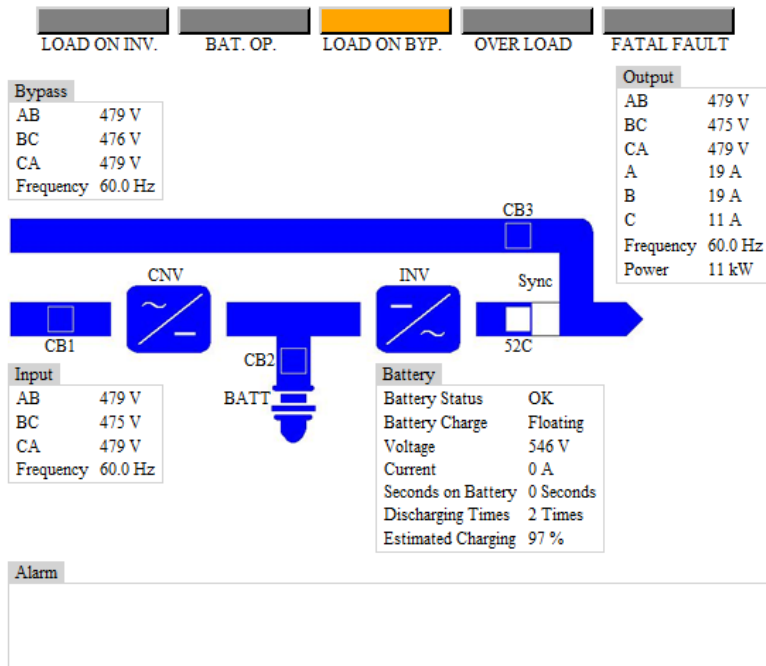
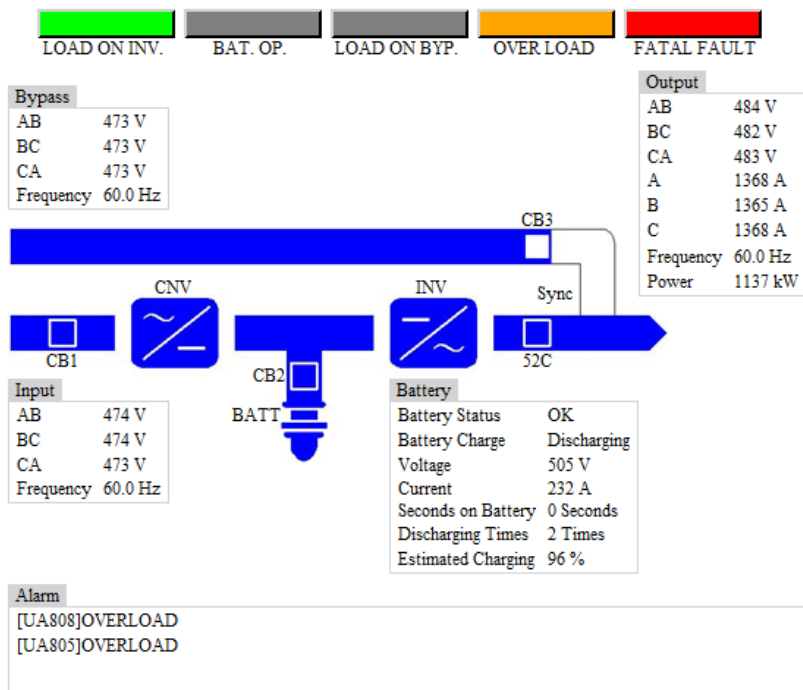
[LOAD ON BYP.]

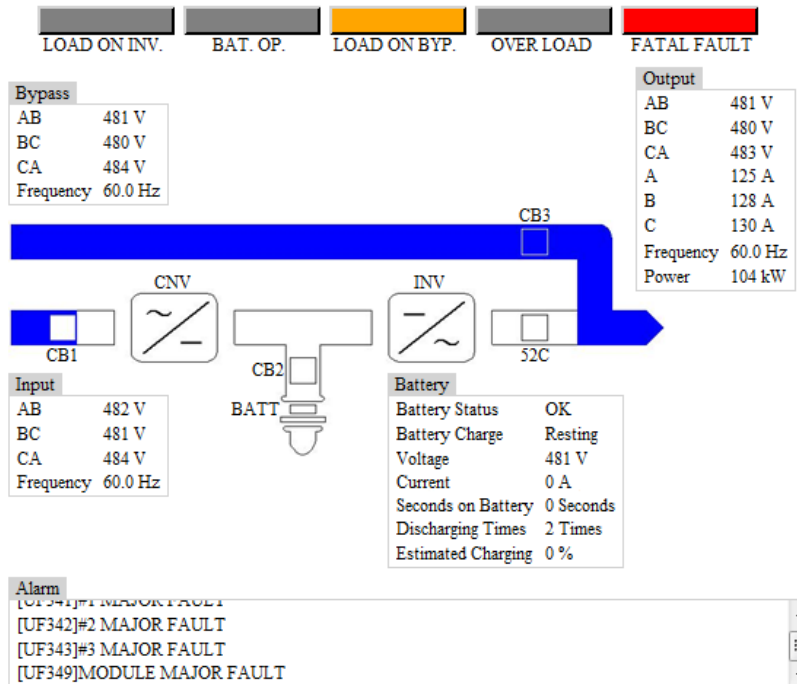
[OVER LOAD]

[FATAL FAULT]

2 Alarm

The Alarm section at the bottom of this screen shows a running log of the most recent UPS Alarms. The UPS Internal History menu will show a more detailed alarm history for the UPS.

4. 3. 2 UPS Internal History

The UPS internal history screen shows the UPS operational/alarm history.



MELUPS 9900B Logged in : admin

View / UPS internal history

Date	Item	Occurred/Cancel
2014/09/18 19:35	[UA817]EMERGENCY STOP ACTIVATED	occurred
2014/09/18 18:40	LOAD ON INVERTER	cancelled
2014/09/18 18:40	[UF204]OUTPUT CIRCUIT ABNORMAL	occurred
2014/09/18 18:40	LOAD ON INVERTER	occurred
2014/09/18 18:38	LOAD ON INVERTER	cancelled
2014/09/18 18:38	LOAD ON INVERTER	occurred
2014/09/18 18:35	[UA817]EMERGENCY STOP ACTIVATED	occurred
2014/09/18 18:25	LOAD ON INVERTER	cancelled
2014/09/18 18:24	LOAD ON INVERTER	occurred
2014/09/18 18:24	[UA801]AC INPUT VOLTAGE OUT OF RANGE	cancelled
2014/09/18 18:24	[UA801]AC INPUT VOLTAGE OUT OF RANGE	occurred
2014/09/18 17:42	[UA817]EMERGENCY STOP ACTIVATED	occurred
2014/09/18 13:45	[UF103]DC UNDER VOLTAGE	occurred
2014/09/18 13:44	LOAD ON INVERTER	cancelled
2014/09/18 13:43	LOAD ON INVERTER	occurred
2014/09/16 19:30	[UA801]AC INPUT VOLTAGE OUT OF RANGE	occurred
2014/09/16 19:30	[UF103]DC UNDER VOLTAGE	occurred
2014/09/16 19:30	LOAD ON INVERTER	cancelled
2014/09/16 19:30	LOAD ON INVERTER	occurred
2014/09/16 19:30	LOAD ON INVERTER	cancelled
2014/09/16 19:30	LOAD ON INVERTER	occurred
2014/09/16 19:29	[UA801]AC INPUT VOLTAGE OUT OF RANGE	cancelled
2014/09/16 19:29	[UA801]AC INPUT VOLTAGE OUT OF RANGE	occurred
2014/09/16 19:23	CB2 CLOSE	cancelled
2014/09/16 19:23	CB2 CLOSE	occurred
2014/09/16 19:23	[UF154]CB2 ABNORMAL	occurred

Description	
1	Date of Event
2	Event Description
3	Event Occurred or Canceled

4. 3. 3 System Information

The System Information screen shows an overview of the UPS system, ratings, and contact address.

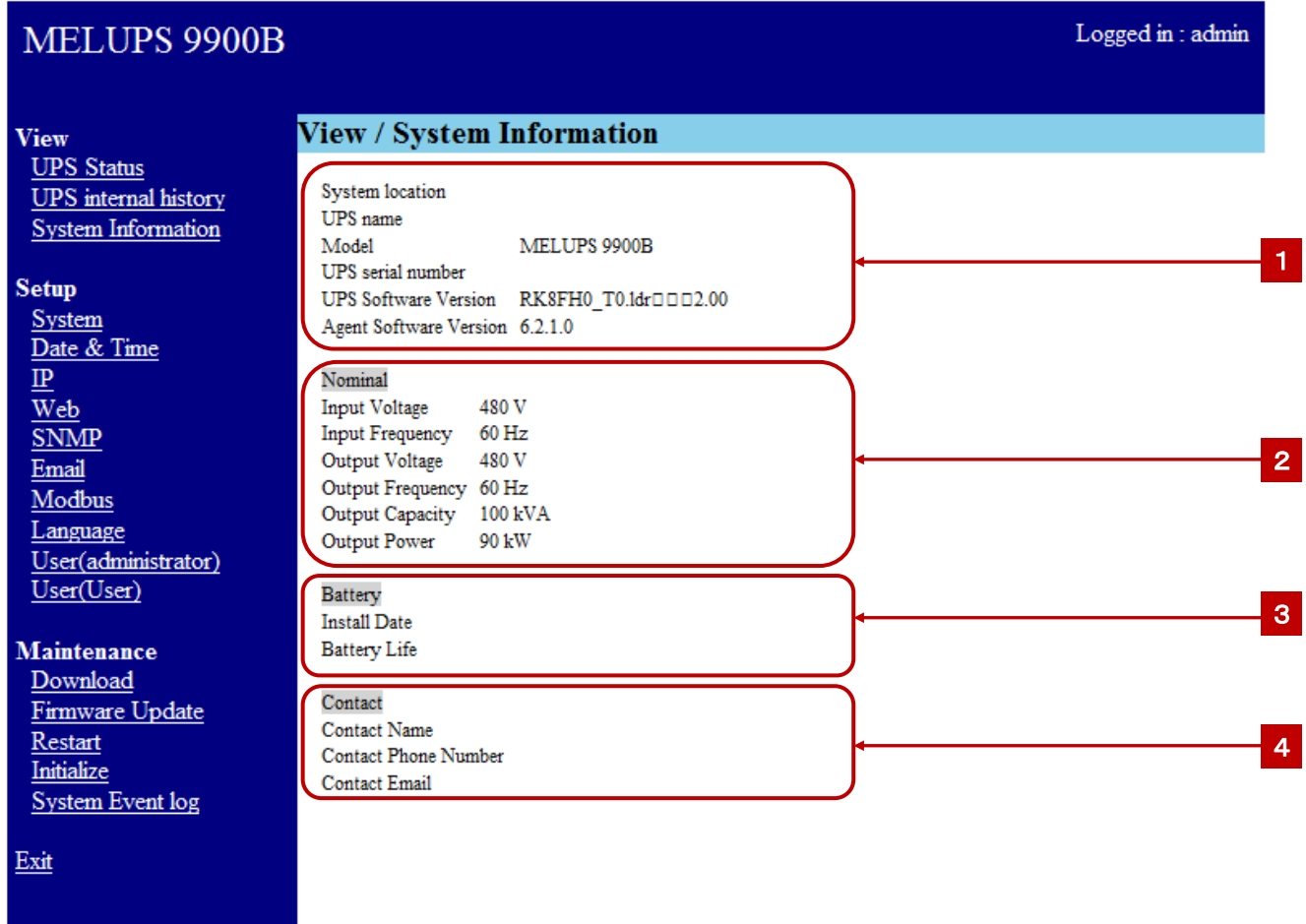

Description	
1	System Location Location UPS is Installed, UPS Name, UPS Model, UPS Serial Number, UPS Software Version, Agent (LookUPS) Software Version
2	Nominal System Ratings: Input Voltage, Input Frequency, Output Voltage, Output Frequency, Output Capacity, and Output Power.
3	Battery Date of installation, Lifetime (in years)
4	Contact Name, Phone Number, and Email Address of system contact person

Note: Information can be filled in during the system setup and will appear on this screen.

4. 4 Setup

4. 4. 1 System

The System screen is used to input customer specific UPS information.

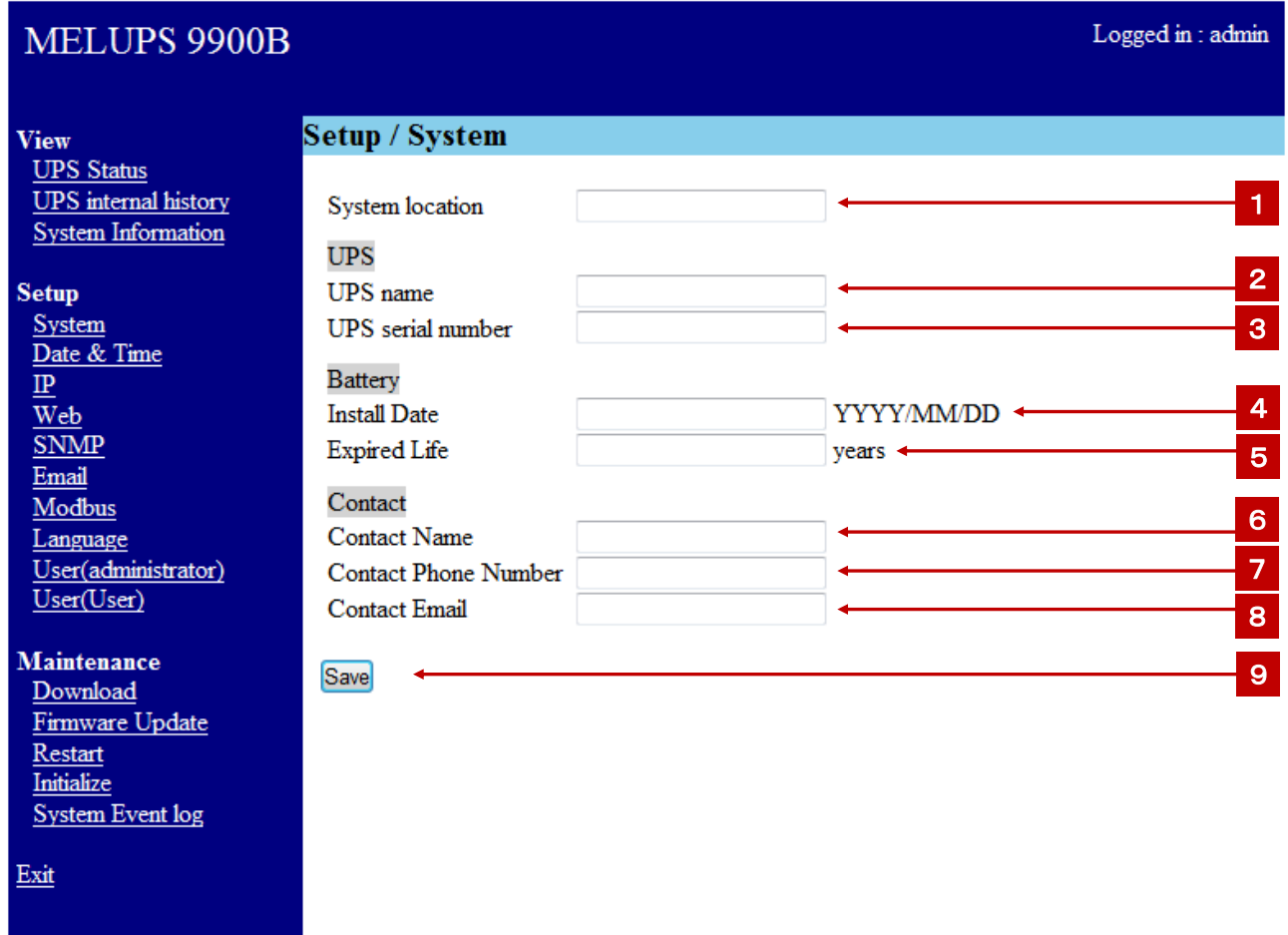

MELUPS 9900B Logged in : admin

View
[UPS Status](#)
[UPS internal history](#)
[System Information](#)

Setup
[System](#)
[Date & Time](#)
[IP](#)
[Web](#)
[SNMP](#)
[Email](#)
[Modbus](#)
[Language](#)
[User\(administrator\)](#)
[User\(User\)](#)

Maintenance
[Download](#)
[Firmware Update](#)
[Restart](#)
[Initialize](#)
[System Event log](#)

[Exit](#)

Setup / System

System location ← 1

UPS

UPS name ← 2

UPS serial number ← 3

Battery

Install Date YYYY/MM/DD ← 4

Expired Life years ← 5

Contact

Contact Name ← 6

Contact Phone Number ← 7

Contact Email ← 8

← 9

Description	
1	System location: Where the UPS is installed
2	UPS name
3	UPS serial number
4	Battery Install Date
5	Expired Life: Battery Lifetime (years)
6	Contact Name: System contact person

7 Contact Phone Number: System contact person

8 Contact Email: System contact person

9 Save: Click here to save the data.

Note: The following characters can NOT be used anywhere in this form. = ? { } & | ~ ! [() ^ "

4. 4. 2 Date & Time

The Date & Time screen is used to set the date and time of the LookUPS. The date and time of LookUPS will be synchronized with the PC connected to it.

NOTE: Be sure that your PC's clock is set to the correct time and date.

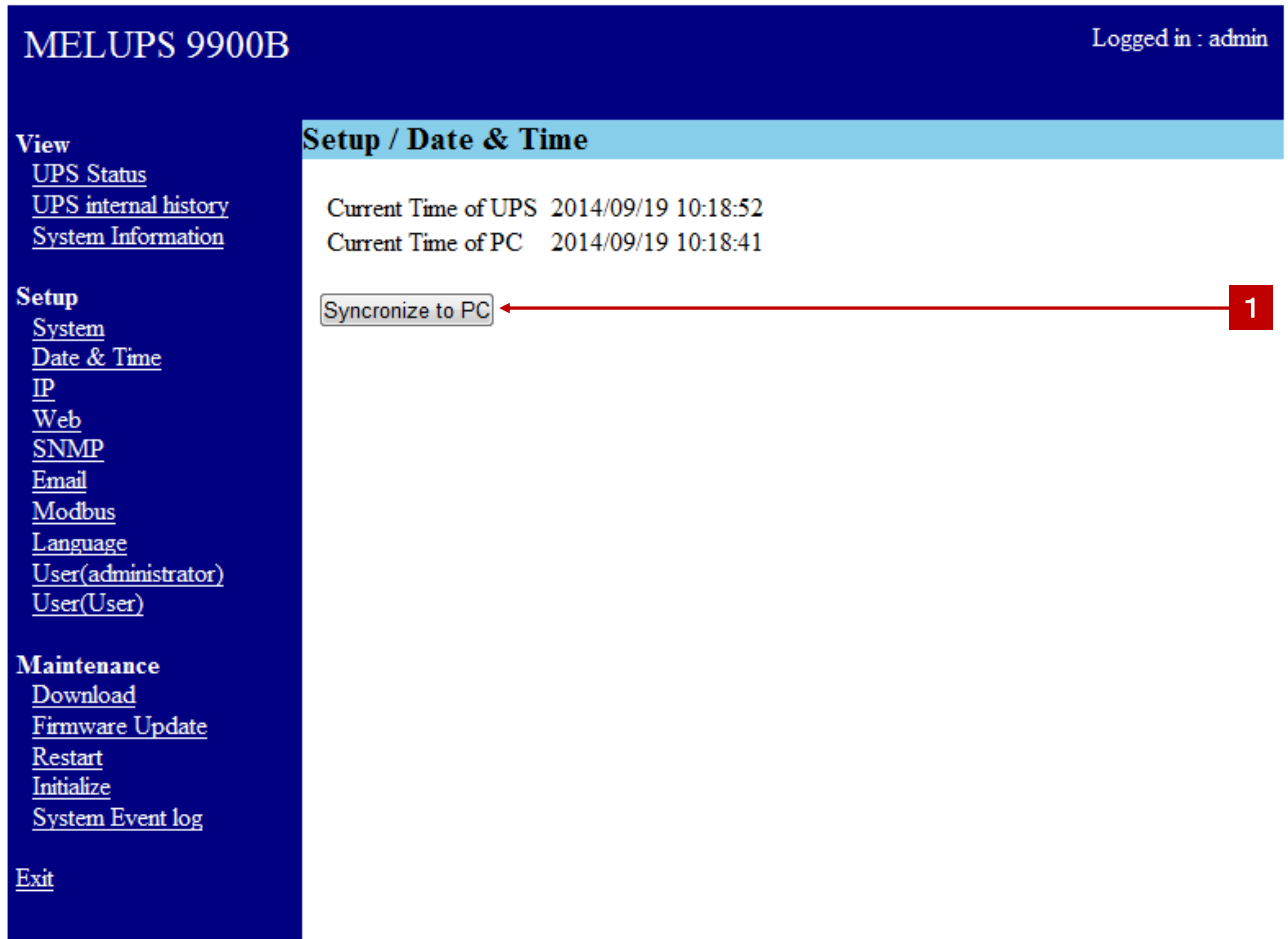

MELUPS 9900B Logged in : admin

View
[UPS Status](#)
[UPS internal history](#)
[System Information](#)

Setup
[System](#)
[Date & Time](#)
[IP](#)
[Web](#)
[SNMP](#)
[Email](#)
[Modbus](#)
[Language](#)
[User\(administrator\)](#)
[User\(User\)](#)

Maintenance
[Download](#)
[Firmware Update](#)
[Restart](#)
[Initialize](#)
[System Event log](#)

[Exit](#)

Setup / Date & Time

Current Time of UPS 2014/09/19 10:18:52
 Current Time of PC 2014/09/19 10:18:41

← 1

Description	
1	Synchronize to PC: Click here to synchronize the date and time with the connected PC.

4. 4. 3 IP

The IP screen is used to assign the correct network settings to the LookUPS.

IMPORTANT: Be sure to record the new IP settings. There is no way to recover the LookUPS if the IP address is forgotten.

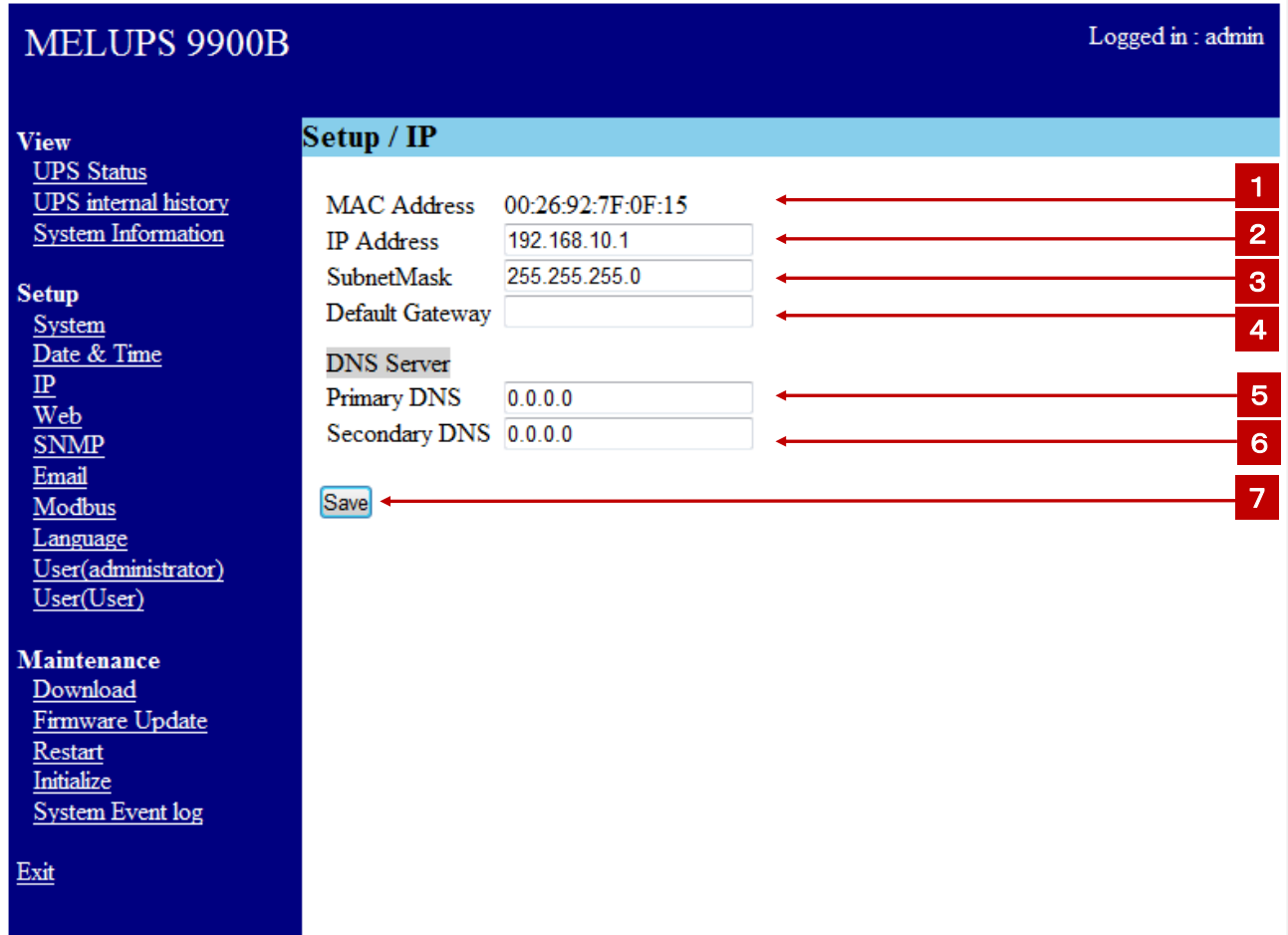

MELUPS 9900B Logged in : admin

View
[UPS Status](#)
[UPS internal history](#)
[System Information](#)

Setup
[System](#)
[Date & Time](#)
[IP](#)
[Web](#)
[SNMP](#)
[Email](#)
[Modbus](#)
[Language](#)
[User\(administrator\)](#)
[User\(User\)](#)

Maintenance
[Download](#)
[Firmware Update](#)
[Restart](#)
[Initialize](#)
[System Event log](#)

[Exit](#)

Setup / IP

MAC Address 00:26:92:7F:0F:15 1

IP Address 192.168.10.1 2

SubnetMask 255.255.255.0 3

Default Gateway 4

DNS Server

Primary DNS 0.0.0.0 5

Secondary DNS 0.0.0.0 6

7

Description	
1	MAC Address
2	IP Address
3	Subnet Mask
4	Default Gateway
5	Primary DNS
6	Secondary DNS

7 Save: Click here to save the data.

4. 4. 4 Web

The Web screen is used to set the HTTP port the LookUPS will use when accessing the web interface.

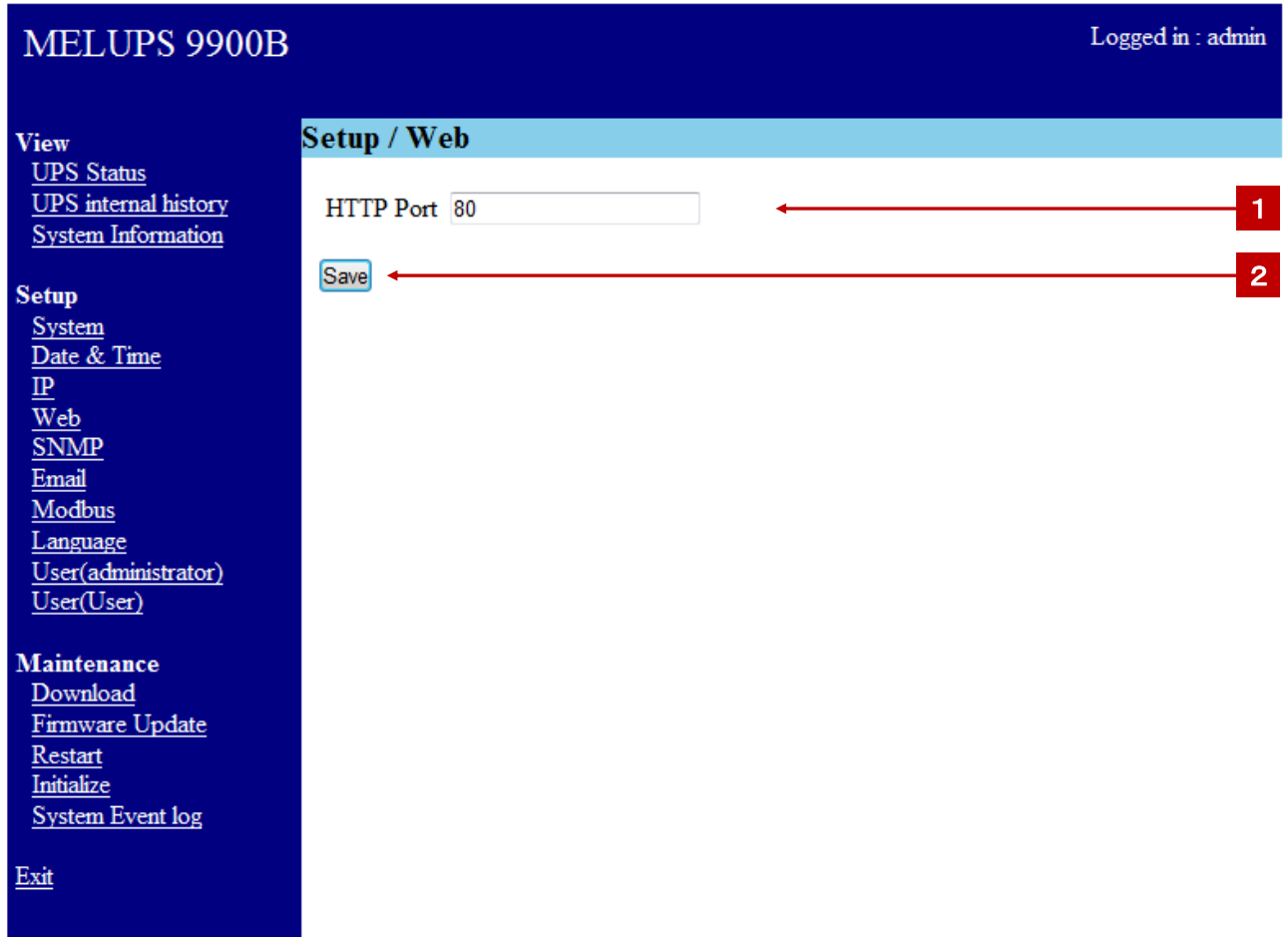

MELUPS 9900B Logged in : admin

View
[UPS Status](#)
[UPS internal history](#)
[System Information](#)

Setup
[System](#)
[Date & Time](#)
[IP](#)
[Web](#)
[SNMP](#)
[Email](#)
[Modbus](#)
[Language](#)
[User\(administrator\)](#)
[User\(User\)](#)

Maintenance
[Download](#)
[Firmware Update](#)
[Restart](#)
[Initialize](#)
[System Event log](#)

[Exit](#)

Setup / Web

HTTP Port **1**

2

Description	
1	HTTP Port
2	Save: Click here to set the data.

4. 4. 5 SNMP

The SNMP screen is for assigning the SNMP settings.

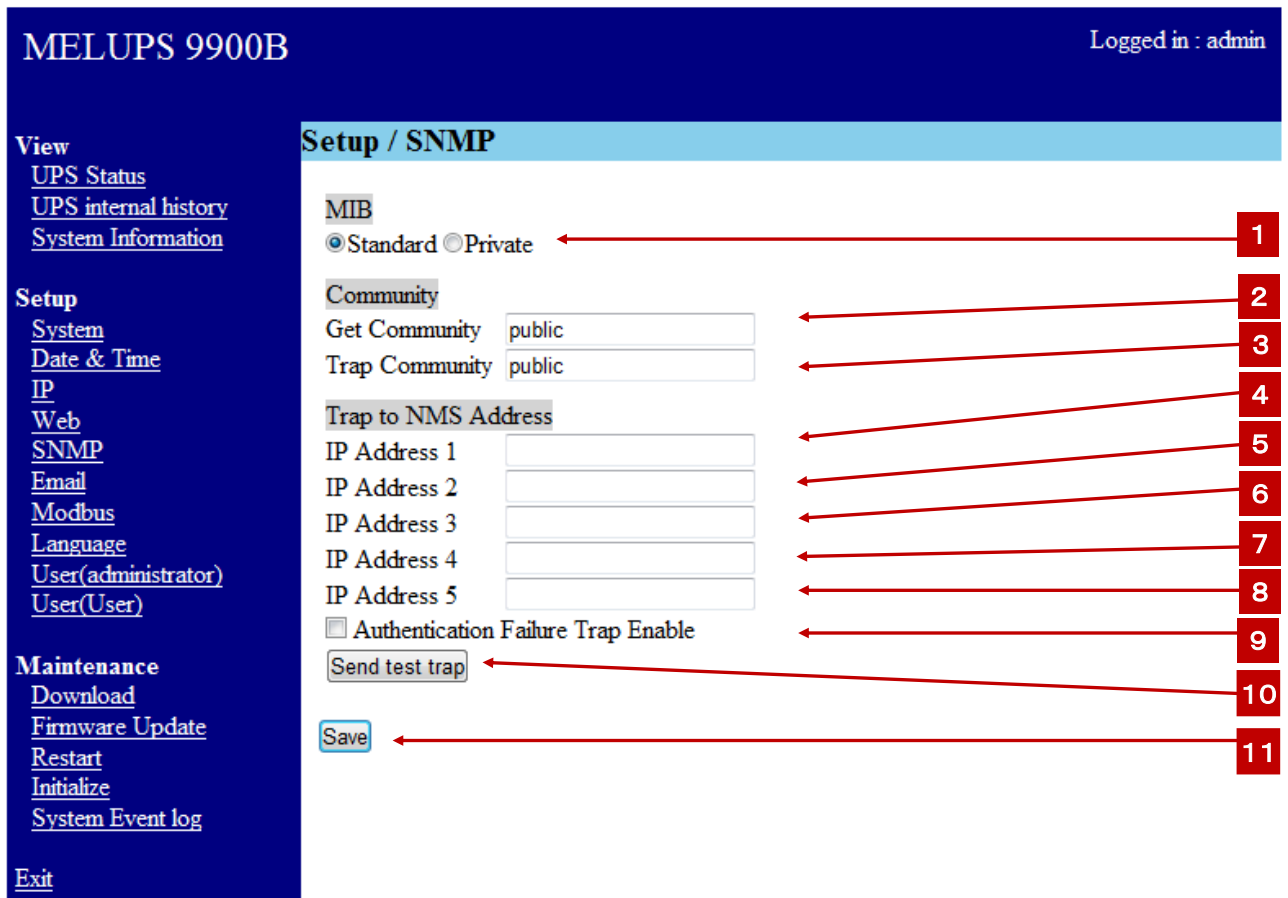

Description	
1	MIB: “Standard” for standard UPS MIB (RFC1628), “Private” for extended JEMA MIB Factory default: “Standard”
2	Get Community Factory default “public”
3	Trap Community Factory default “public”
4 ~ 8	Trap to NMS Address 1~5 IP address of Trap destinations
9	Authentication Failure Trap Enable: check to enable the Trap in case of authentication failure
10	Send test trap: Click to send test trap to the IP addresses listed above. The Trap transmission is “upsTrapAlarmEntryAdded” mentioned in the SNMP descriptions.
11	Save: Click to save the data

Note: The following characters can NOT be used anywhere in this form. = ? { } & | ~ ! [() ^ " "

4. 4. 6 Email

The Email screen is for assigning the Email settings.

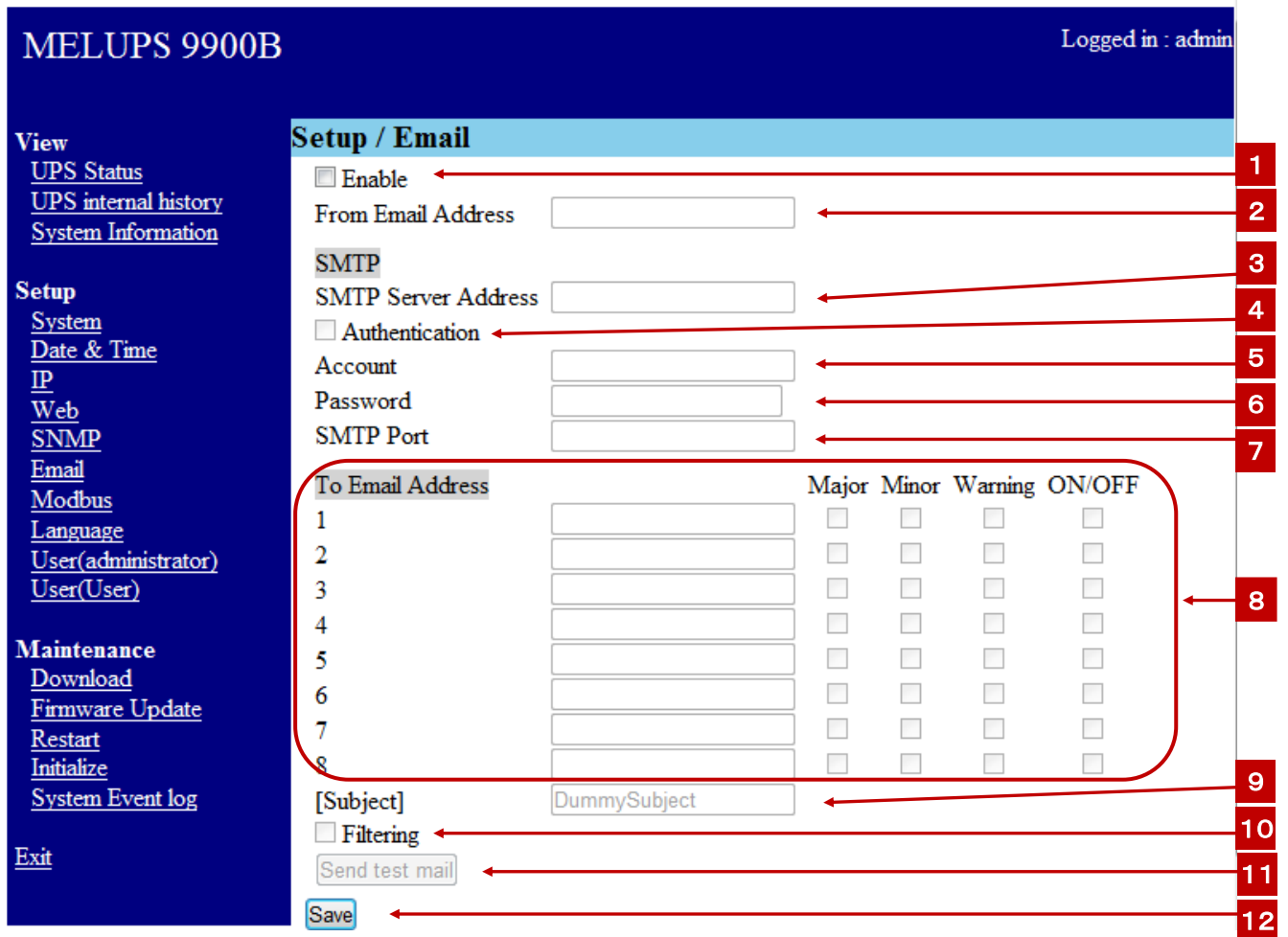

MELUPS 9900B Logged in : admin

View
[UPS Status](#)
[UPS internal history](#)
[System Information](#)

Setup
[System](#)
[Date & Time](#)
[IP](#)
[Web](#)
[SNMP](#)
[Email](#)
[Modbus](#)
[Language](#)
[User\(administrator\)](#)
[User\(User\)](#)

Maintenance
[Download](#)
[Firmware Update](#)
[Restart](#)
[Initialize](#)
[System Event log](#)

[Exit](#)

Setup / Email

Enable

From Email Address

SMTP

SMTP Server Address

Authentication

Account

Password

SMTP Port

To Email Address	Major	Minor	Warning	ON/OFF
1	<input type="checkbox"/>	<input type="checkbox"/>	<input type="checkbox"/>	<input type="checkbox"/>
2	<input type="checkbox"/>	<input type="checkbox"/>	<input type="checkbox"/>	<input type="checkbox"/>
3	<input type="checkbox"/>	<input type="checkbox"/>	<input type="checkbox"/>	<input type="checkbox"/>
4	<input type="checkbox"/>	<input type="checkbox"/>	<input type="checkbox"/>	<input type="checkbox"/>
5	<input type="checkbox"/>	<input type="checkbox"/>	<input type="checkbox"/>	<input type="checkbox"/>
6	<input type="checkbox"/>	<input type="checkbox"/>	<input type="checkbox"/>	<input type="checkbox"/>
7	<input type="checkbox"/>	<input type="checkbox"/>	<input type="checkbox"/>	<input type="checkbox"/>
8	<input type="checkbox"/>	<input type="checkbox"/>	<input type="checkbox"/>	<input type="checkbox"/>

[Subject]

Filtering

Description	
1	Enable: Check to enable Email alarm - Checked: Email alarms are sent. - Non-Checked: Email alarms are not sent
2	From Email Address: Input the Email address of the sender
3	SMTP Server Address
4	Authentication: Check to enable SMTP account
5	Account: SMTP account
6	Password: SMTP account
7	SMTP Port: The SMTP port number

8 To Email Address: Input the Email address that is to receive the email alarms
Check to set which events send an email alarm and to what email.
【Major】: Major fault, 【Minor】: Minor fault, 【Warning】: Warning
【ON/OFF】: Check to enable or disable the Email alarm for each destination.

9 Subject

10 Filtering: Check to enable filtering function

11 Send test mail: Click to send a test mail to the destinations specified above.

12 Save: Click to save the data

Note: The following characters can NOT be used anywhere in this form. = ? { } & | ~ ! [() ^ " "

4. 4. 7 Modbus

The Modbus screen is to assign the Slave Address for Modbus.

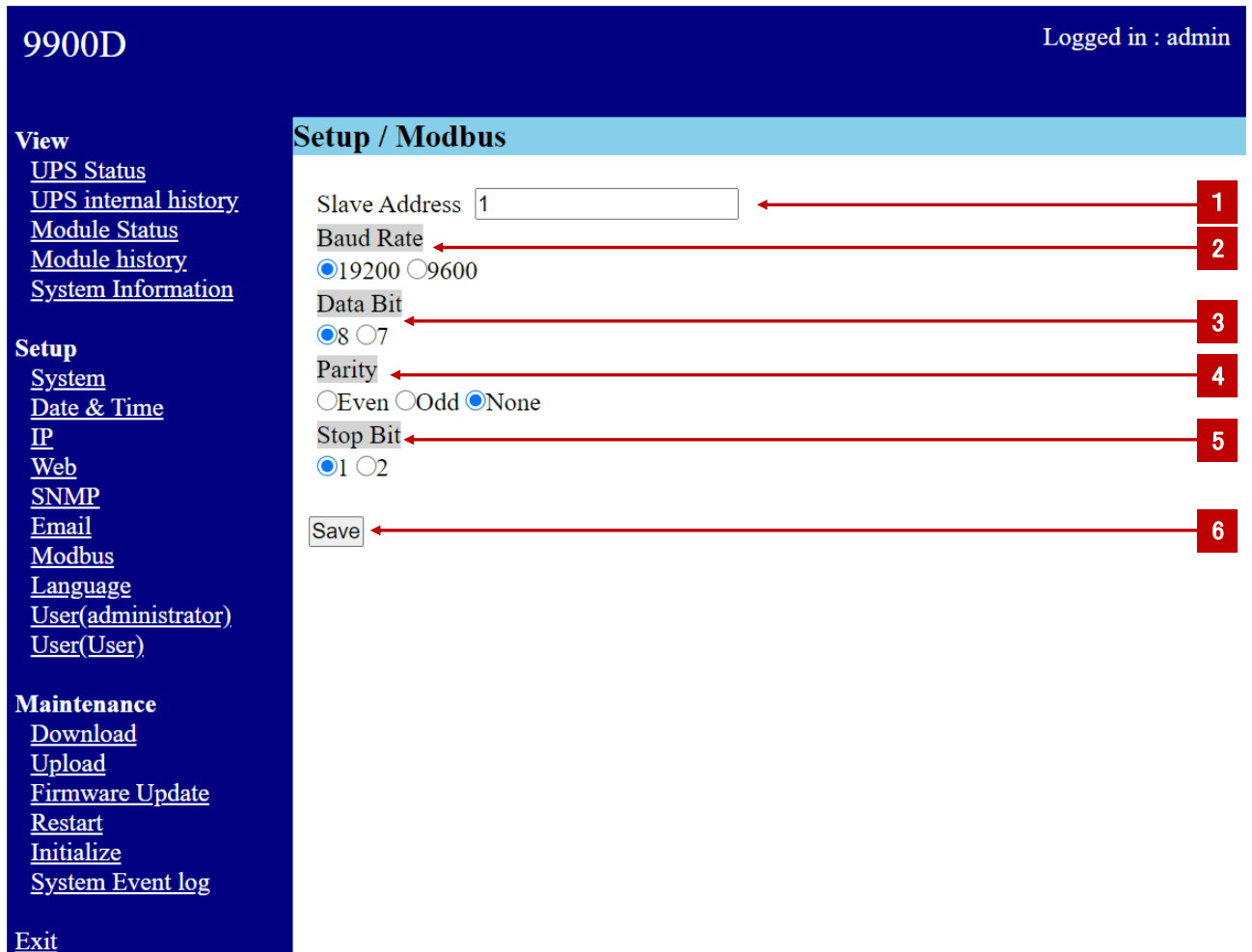

9900D Logged in : admin

View
[UPS Status](#)
[UPS internal history](#)
[Module Status](#)
[Module history](#)
[System Information](#)

Setup
[System](#)
[Date & Time](#)
[IP](#)
[Web](#)
[SNMP](#)
[Email](#)
[Modbus](#)
[Language](#)
[User\(administrator\)](#)
[User\(User\)](#)

Maintenance
[Download](#)
[Upload](#)
[Firmware Update](#)
[Restart](#)
[Initialize](#)
[System Event log](#)

[Exit](#)

Setup / Modbus

Slave Address 1

Baud Rate 2
19200 9600

Data Bit 3
8 7

Parity 4
Even Odd None

Stop Bit 5
1 2

6

Description	
1	Slave Address Default: 1
2	Baud Rate Default: 19200
3	Data Bit Default: 8
4	Parity Default: None
5	Stop Bit Default: 1
6	Save: Click to save the data

4. 4. 8 Language

The language screen is used to choose the language of the web interface.

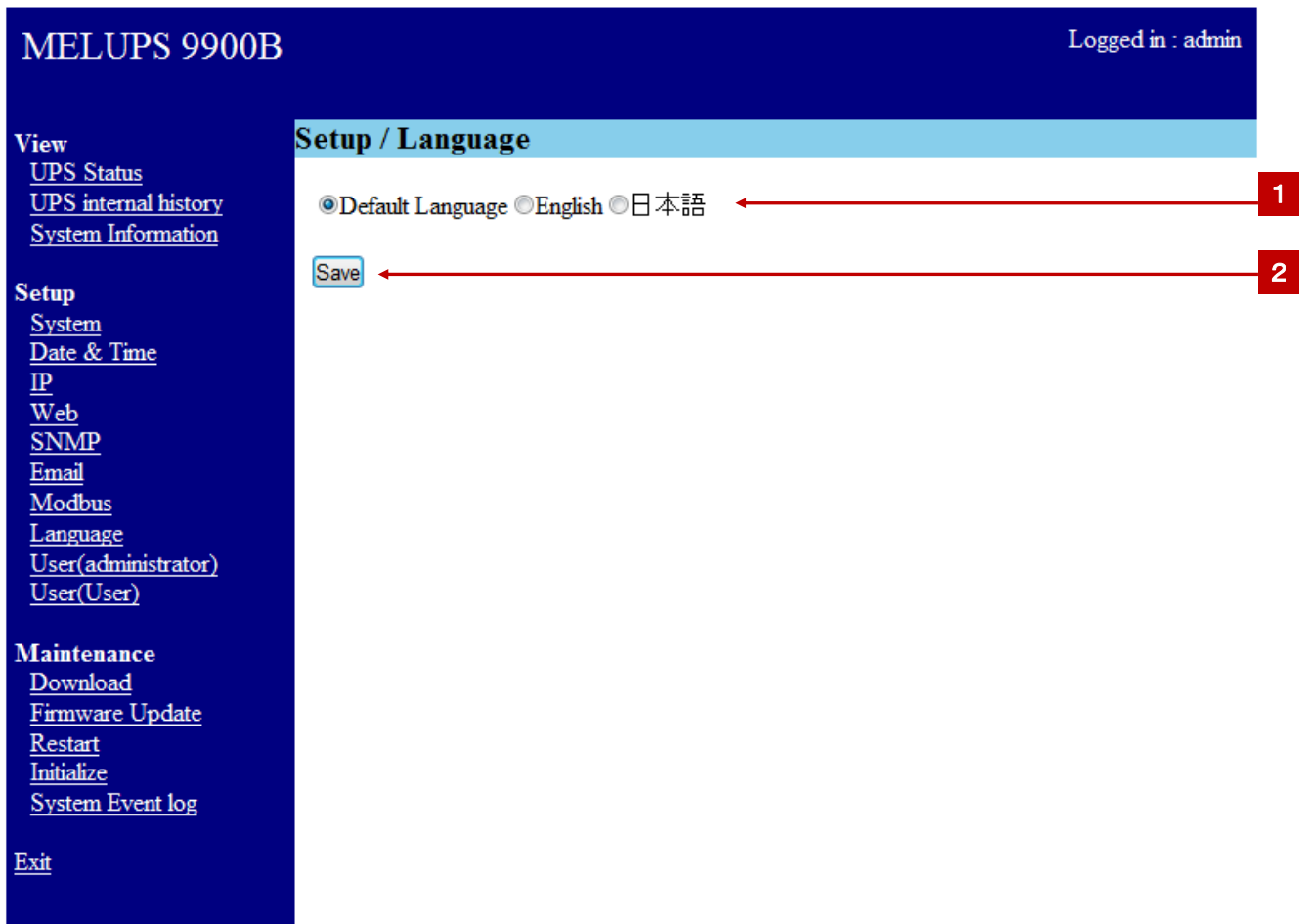

Description	
1	Language Default: Default Language (according to web browser's settings)
2	Save: Click to save the data

4. 4. 9 User(administrator)

The User(administrator) screen is only available to the administrator. The administrator can change the username and password of users on this screen.

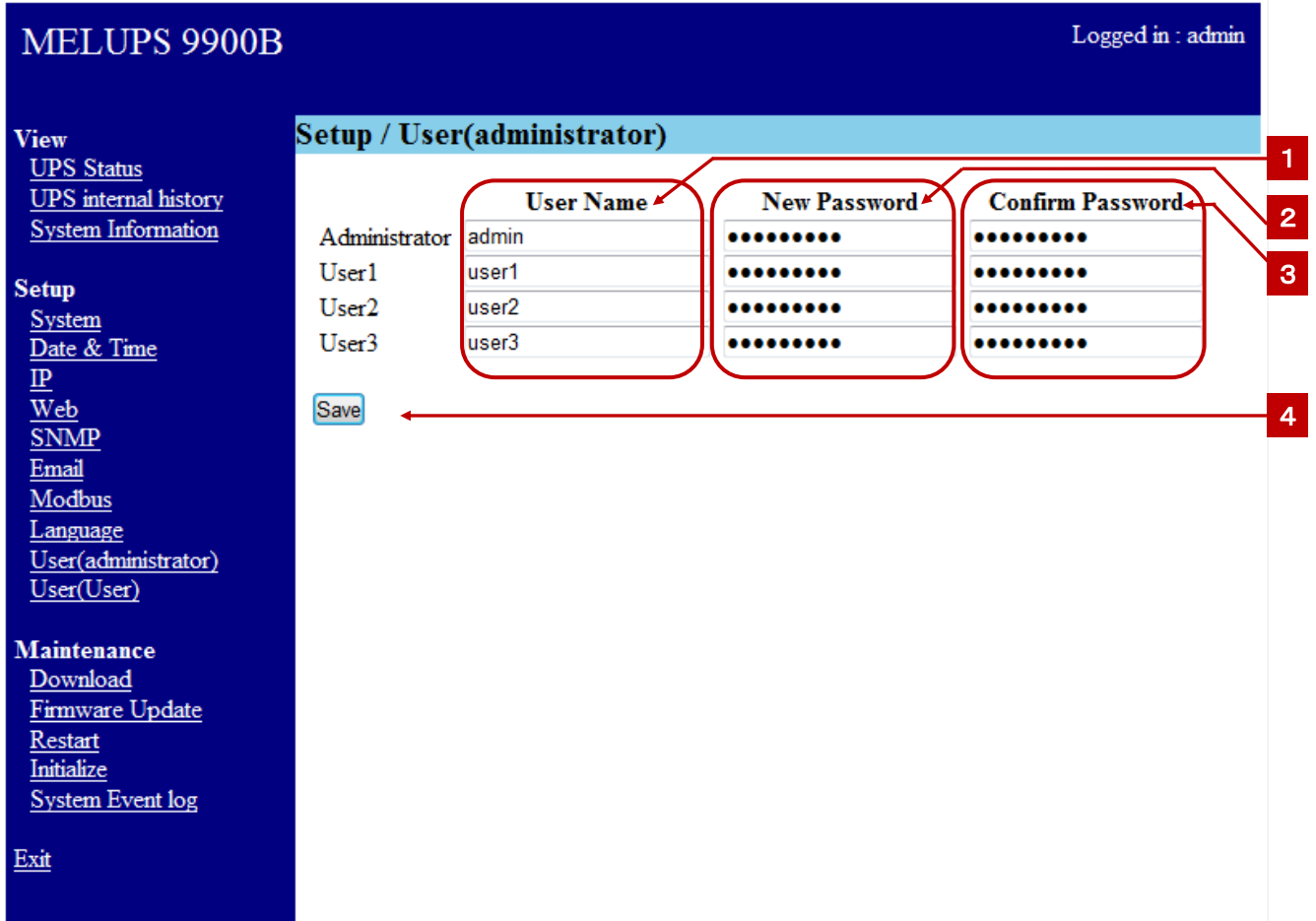

MELUPS 9900B Logged in : admin

Setup / User(administrator)

	User Name	New Password	Confirm Password
Administrator	admin
User1	user1
User2	user2
User3	user3

Description	
1	User Name: Input each Username
2	New Password: Input a new password
3	Confirm Password: Enter and confirm the new password again.
4	Save: Click to save the data

Note: The following characters can NOT be used anywhere in this form. = ? { } & | ~ ! [() ^ " ' `

4. 4. 10 User(User)

The User(User) screen allows a user currently logged in to change their password.

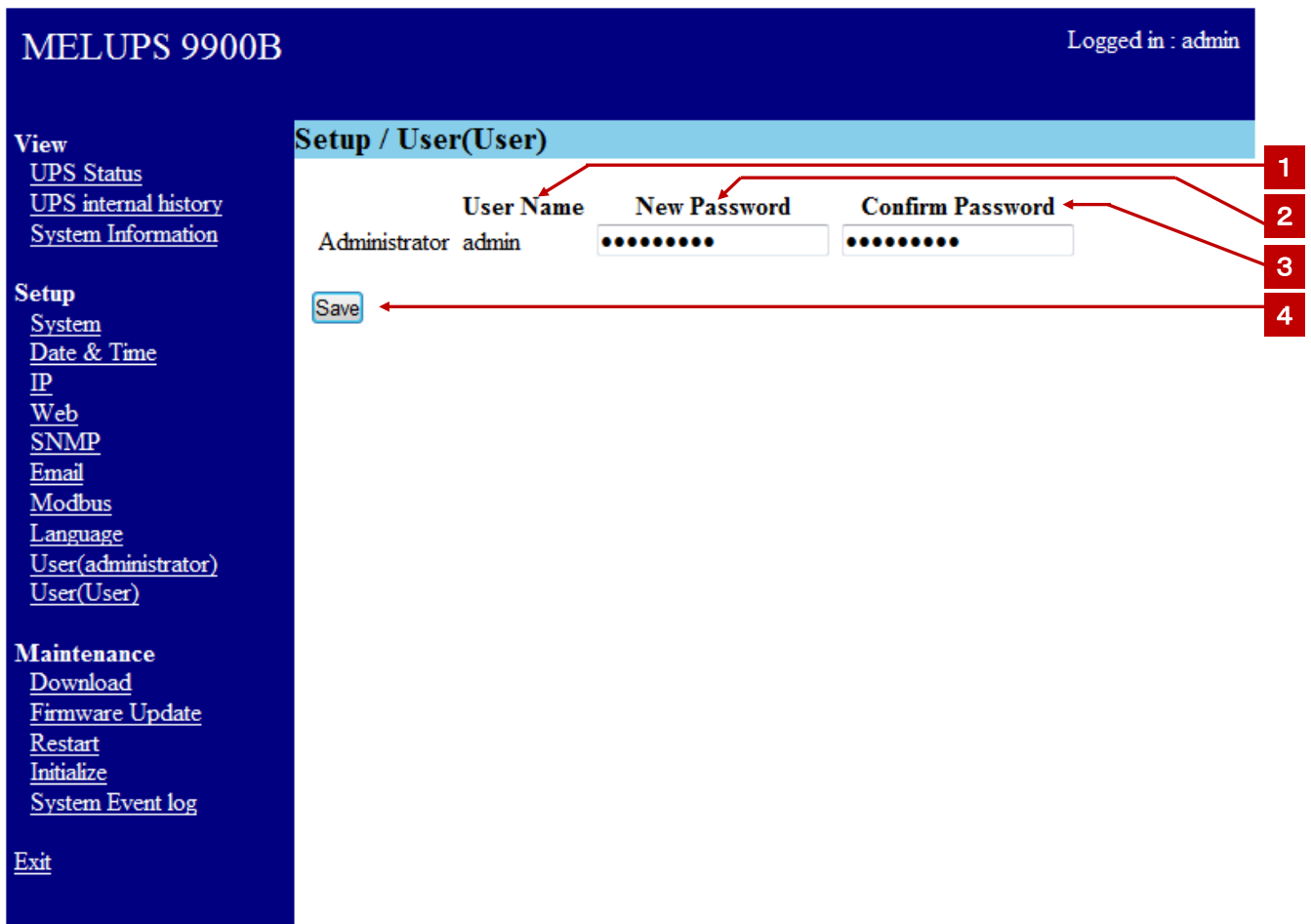

Description	
1	User Name: NOT changeable (assigned to the currently logged in user)
2	New Password
3	Confirm Password
4	Save: Click to save the data

Note: The following characters can NOT be used anywhere in this form. = ? { } & | ~ ! [() ^ " "

4. 5 Maintenance

4. 5. 1 Download

The Download screen is used to download a config file that contains the settings of the LookUPS board. This file can be opened and read with a text editing application to view the settings of the LookUPS board at the time of download.

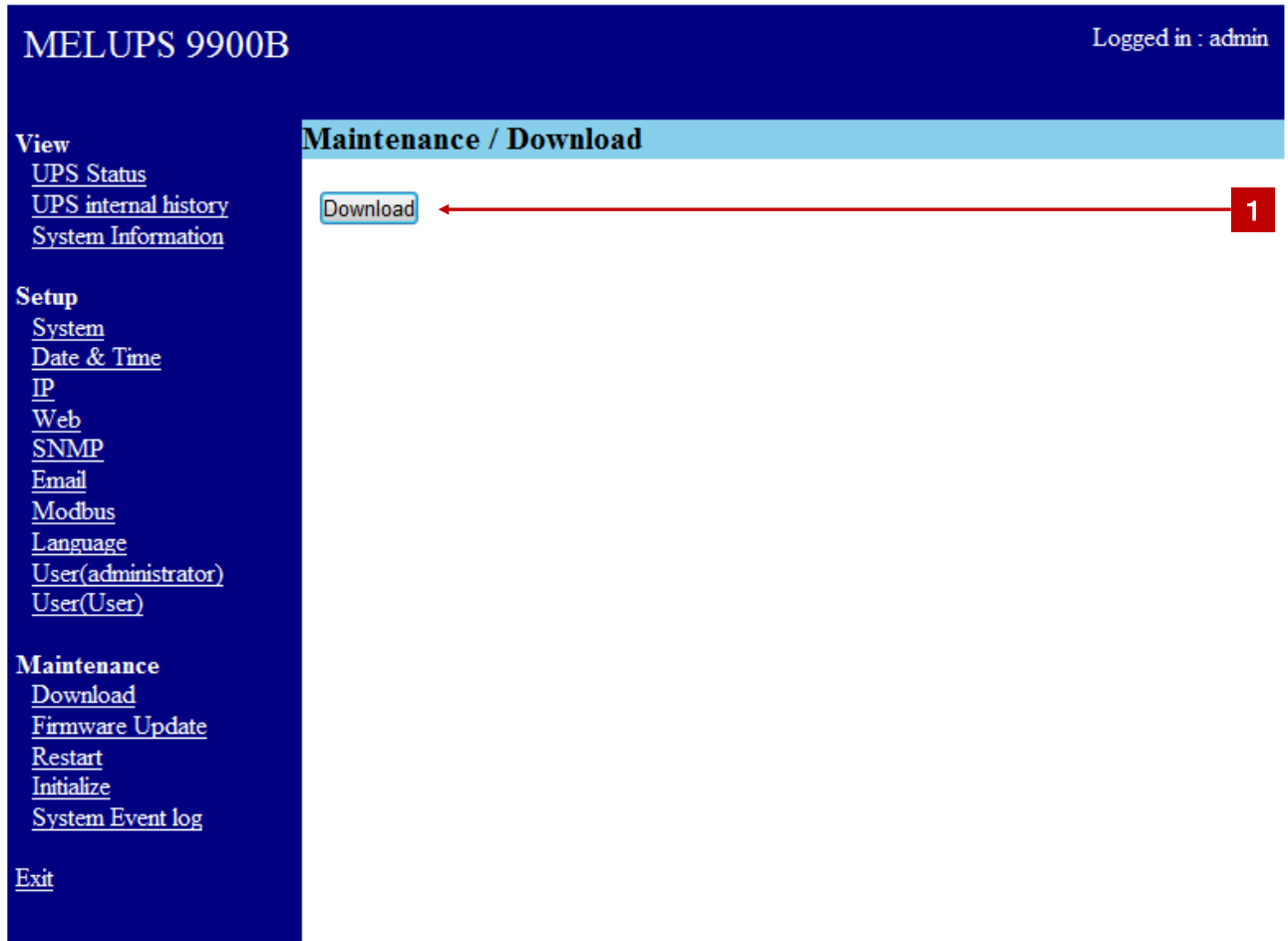

MELUPS 9900B Logged in : admin

View
[UPS Status](#)
[UPS internal history](#)
[System Information](#)

Setup
[System](#)
[Date & Time](#)
[IP](#)
[Web](#)
[SNMP](#)
[Email](#)
[Modbus](#)
[Language](#)
[User\(administrator\)](#)
[User\(User\)](#)

Maintenance
[Download](#)
[Firmware Update](#)
[Restart](#)
[Initialize](#)
[System Event log](#)

[Exit](#)

Maintenance / Download

[Download](#) ← **1**

Description	
1	Download: Click to download the config file (config.ini)

4. 5. 2 Firmware Update

The Firmware Update screen is used to complete a firmware upgrade for the LookUPS board.

NOTE: This function is not used for re-uploading the “config.ini” file, but rather for the LookUPS board’s firmware, which has a “.tgz” extension.



The screenshot shows the MELUPS 9900B web interface. The top header displays 'MELUPS 9900B' and 'Logged in : admin'. The left sidebar contains navigation menus for 'View', 'Setup', 'Maintenance', and 'Exit'. The main content area is titled 'Maintenance / Firmware Update' and features a 'Firmware File:' input field with a '参照...' (Open) button. Below the input field is an 'Update' button. Red arrows and numbered boxes (1 and 2) indicate the sequence of actions: 1 points to the '参照...' button and 2 points to the 'Update' button.

Description	
1	Firmware File Click “Open” to choose a Firmware file (“.tgz” extension).
2	Update Click to start the Firmware Update.

4. 5. 3 Restart

The Restart screen is used to perform a restart of the LookUPS board.

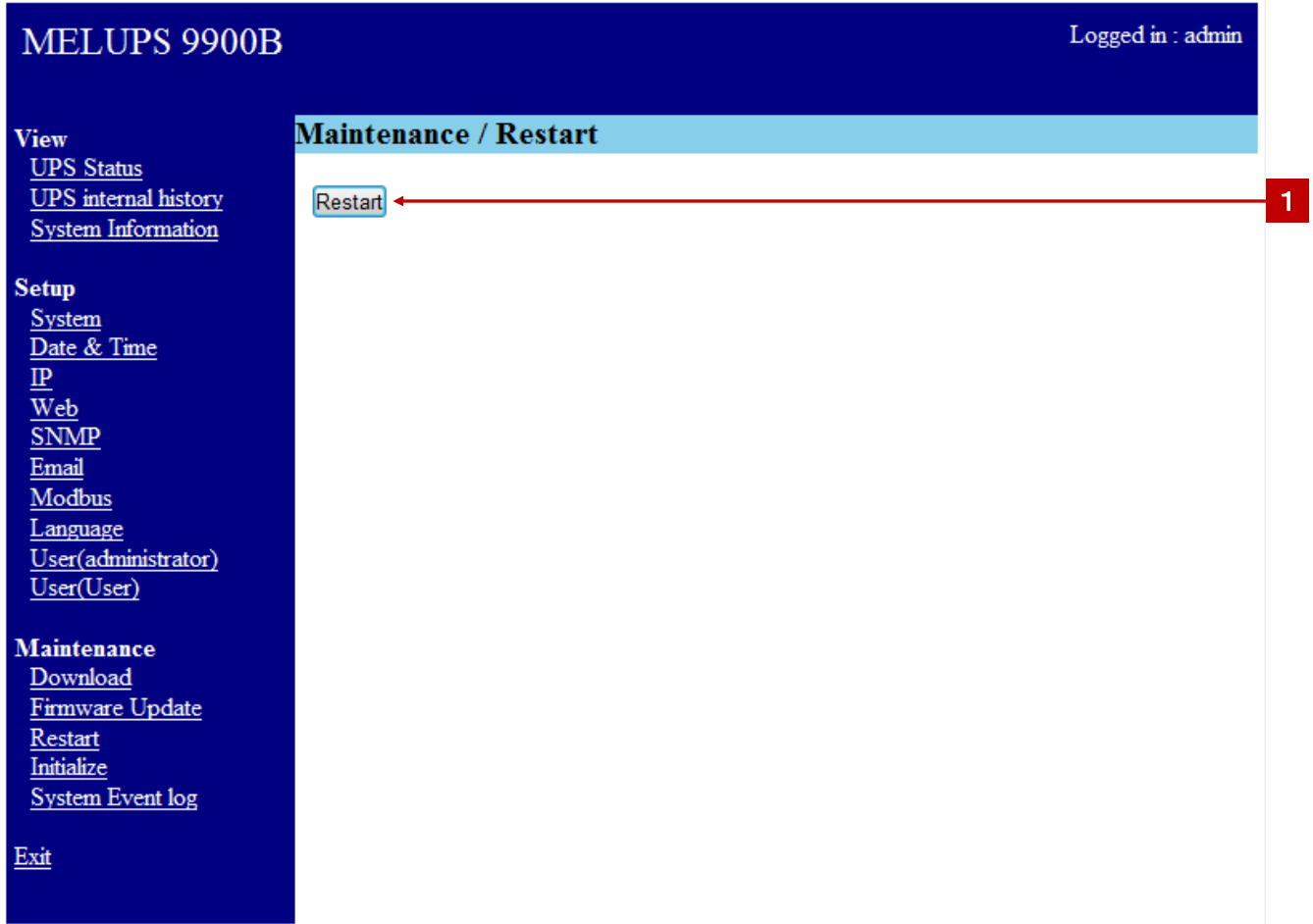

Description	
1	Restart: Click to restart the LookUPS board.

NOTE

- 1) To login, if refreshing the web browser doesn't work, close and reopen web browser.
- 2) It takes about a minute to complete the restart.
- 3) This operation is to restart the LookUPS board only, not to restart the UPS itself.

4. 5. 4 Initialize

The Initialize screen is used to do a factory reset of the LookUPS board. Initializing will restore all settings to the factory default, so be sure to download the config.ini file for records of your current configuration.

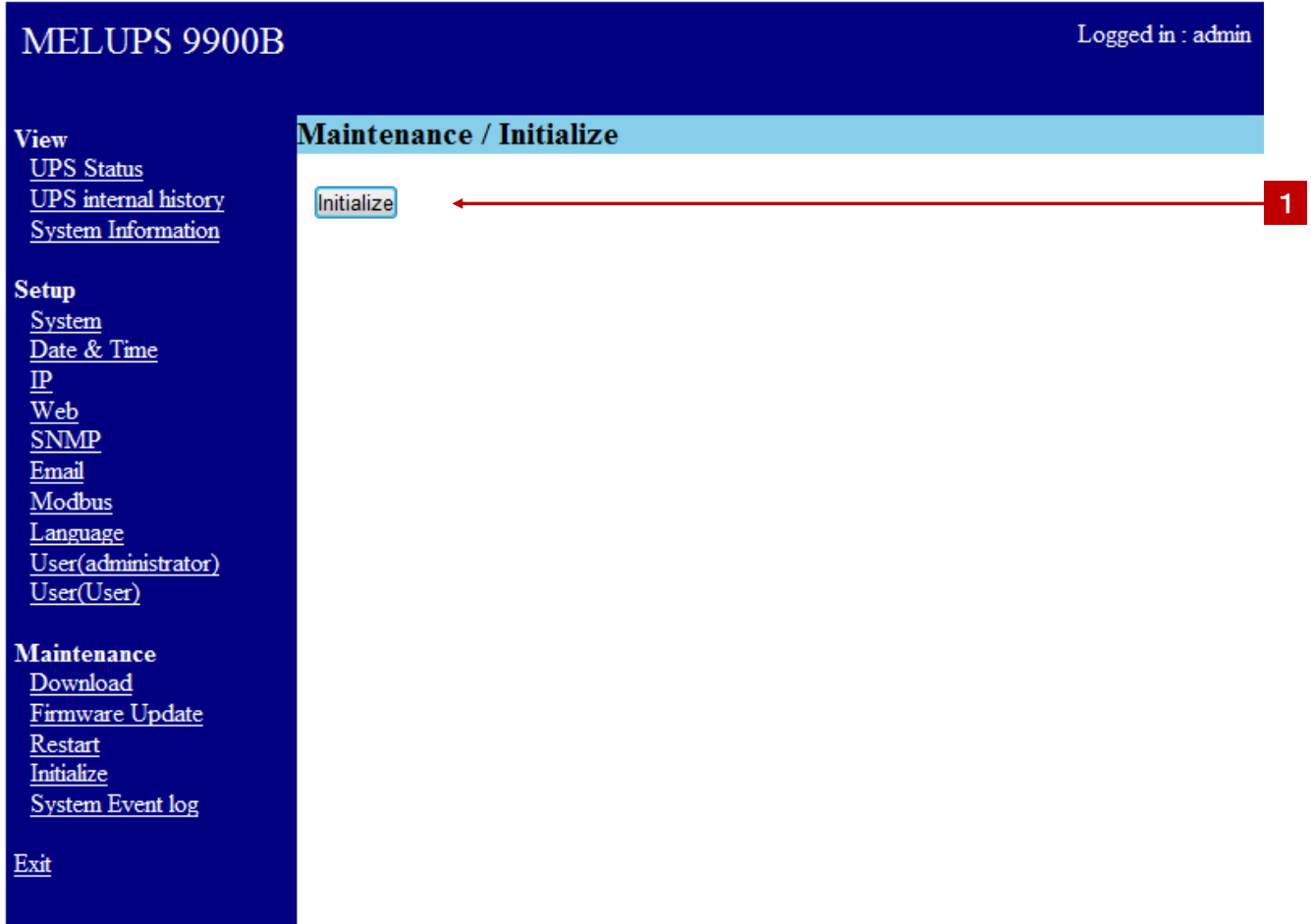

The screenshot shows the MELUPS 9900B web interface. The top header displays 'MELUPS 9900B' and 'Logged in : admin'. The main content area is titled 'Maintenance / Initialize' and contains a single button labeled 'Initialize'. A red arrow points from a red box with the number '1' to the 'Initialize' button. The left sidebar contains a navigation menu with sections: View (UPS Status, UPS internal history, System Information), Setup (System, Date & Time, IP, Web, SNMP, Email, Modbus, Language, User(administrator), User(User)), Maintenance (Download, Firmware Update, Restart, Initialize, System Event log), and Exit.

Description	
1	Initialize Click to Initialize the LookUPS board to its factory default settings.

NOTE

- 1) The board should reset itself after initialization, user will have to log back into the web interface.
- 2) It takes about a minute to complete the initialization.
- 3) This operation is to initialize the LookUPS board only, not to initialize the UPS itself.

4. 5. 5 System Event log

The System Event log screen displays all the LookUPS board events. This screen does not show UPS related events, only board level events. Use the UPS internal history screen for UPS events.

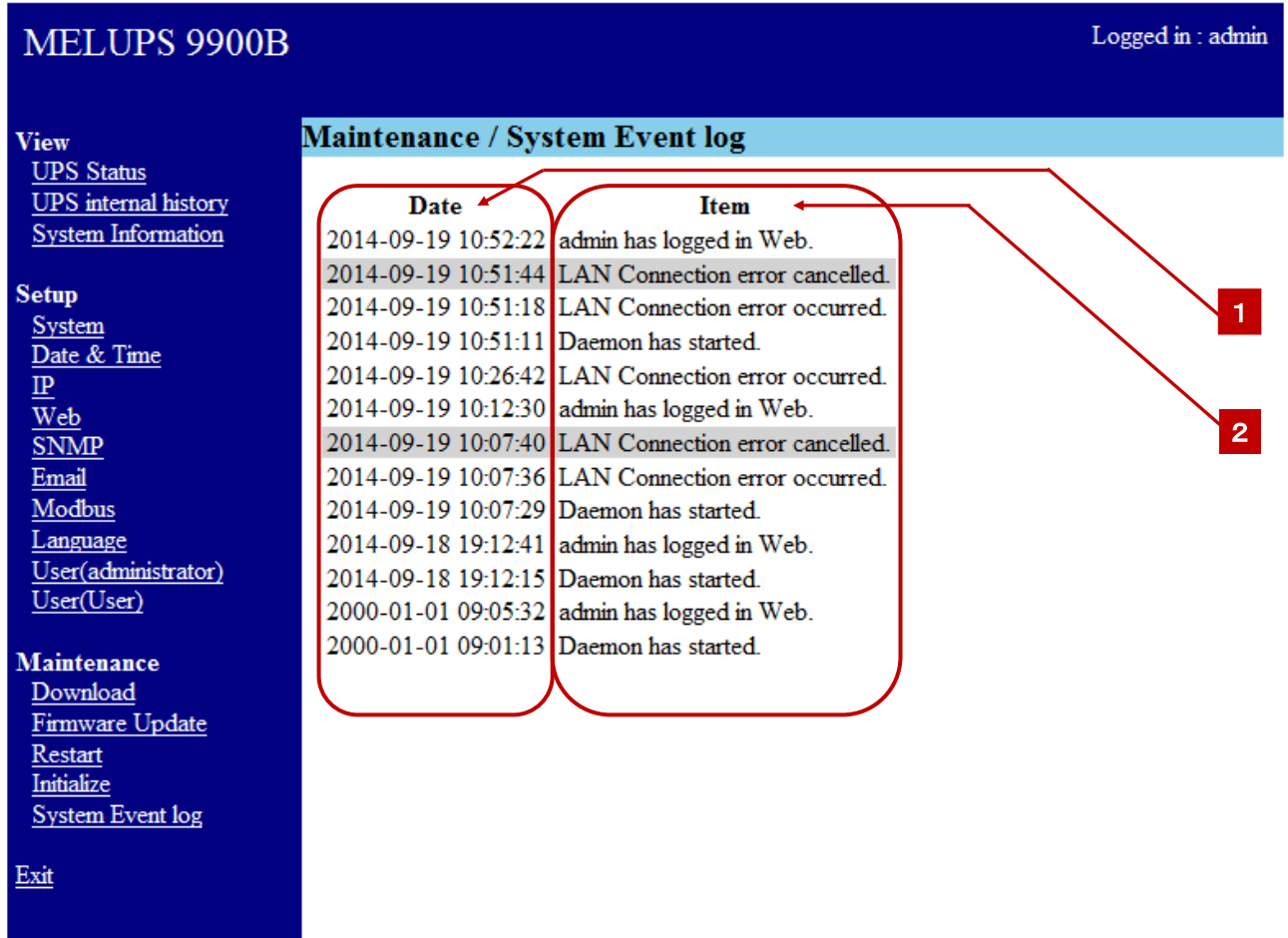

MELUPS 9900B Logged in : admin

Maintenance / System Event log

Date	Item
2014-09-19 10:52:22	admin has logged in Web.
2014-09-19 10:51:44	LAN Connection error cancelled.
2014-09-19 10:51:18	LAN Connection error occurred.
2014-09-19 10:51:11	Daemon has started.
2014-09-19 10:26:42	LAN Connection error occurred.
2014-09-19 10:12:30	admin has logged in Web.
2014-09-19 10:07:40	LAN Connection error cancelled.
2014-09-19 10:07:36	LAN Connection error occurred.
2014-09-19 10:07:29	Daemon has started.
2014-09-18 19:12:41	admin has logged in Web.
2014-09-18 19:12:15	Daemon has started.
2000-01-01 09:05:32	admin has logged in Web.
2000-01-01 09:01:13	Daemon has started.

1 → Date
2 → Item

Description	
1 Date	The date when the event occurred.
2 Item	Description of the event

5. Email Notification Function

This is an example of the email notification sent out during a UPS alarm event. This particular email format is for a UPS input abnormality detected.

From	From Email Address set on "4.4.6 Email"	
To	To Email Address set on "4.4.6 Email"	
Subject	Subject set on "4.4.6 Email"	
Body	If the battery operation starts.	OnBattery occurred.[Event Name] SysName:[UPS name set on "4.4.1 System"] SysLocation:[System location set on "4.4.1 System"]
	If normal operation resumes.	OnBattery recovered.[Event Name] SysName:[UPS name set on "4.4.1 System"] SysLocation:[System location set on "4.4.1 System"]
	If the battery voltage decreases.	LowBattery occurred.[Event Name] SysName:[UPS name set on "4.4.1 System"] SysLocation:[System location set on "4.4.1 System"]
	If the battery voltage returns to normal.	LowBattery recovered.[Event Name] SysName:[UPS name set on "4.4.1 System"] SysLocation:[System location set on "4.4.1 System"]

Refer to "4.4.6 Email" for Email settings.

Refer to "4.4.1 System" for System settings.

6. SNMP Agent Function

A SNMP V2C Trap can be sent from the ShutCom in case of UPS input abnormality detection. Refer to "4.4.5 SNMP" for the settings.

6. 1 UPS MIB (RFC1628)

6. 1. 1 SNMP Get

This board deals with the standard UPS MIB (RFC1628) of listed objects below.

Object-id	Name	Data Type	Access	Description
33.1.1.1	upsIdentManufacturer	OCTET STRING	Read-Only	"MITSUBISHI"
33.1.1.2	upsIdentModel	OCTET STRING	Read-Only	For example, "MELUPS 2133C"
33.1.1.3	upsIdentUPSSoftwareVersion	OCTET STRING	Read-Only	For example, "XXXXXX YYYYYY" (12 digits)
33.1.1.4	upsIdentAgentSoftwareVersion	OCTET STRING	Read-Only	For example, "7.1.0.1"
33.1.1.5	upsIdentName	OCTET STRING	Read-Only	UPS serial number
33.1.1.6	upsIdentAttachedDevice	OCTET STRING	Read-Only	Factory default: empty string
33.1.2.1	upsBatteryStatus	INTEGER	Read-Only	1 = (unknown) 2 = normal 3 = low battery voltage 4 = battery depleted
33.1.2.2	upsSecondsOnBattery	INTEGER	Read-Only	Battery operation time in seconds
33.1.2.3	upsEstimatedMinutesRemaining	INTEGER	Read-Only	0 (fixed)*
33.1.2.4	upsEstimatedChargeRemaining	INTEGER	Read-Only	0 (fixed)*
33.1.2.5	upsBatteryVoltage	INTEGER	Read-Only	Battery voltage (unit: 0.1V)
33.1.2.6	upsBatteryCurrent	Integer32	Read-Only	Battery current (unit: 0.1A)
33.1.2.7	upsBatteryTemperature	Integer32	Read-Only	Battery temperature (°C)
33.1.3.1	upsInputLineBads	Counter32	Read-Only	Number of UPS input abnormality event
33.1.3.2	upsInputNumLines	INTEGER	Read-Only	3 (fixed)
33.1.3.3.1.1	upsInputLineIndex	INTEGER	Unsupported	Unsupported
33.1.3.3.1.2.1	upsInputFrequency	INTEGER	Read-Only	Input frequency 1 (unit: 0.1Hz)
33.1.3.3.1.2.2	upsInputFrequency	INTEGER	Read-Only	Input frequency 2 (0 (fixed)*)
33.1.3.3.1.2.3	upsInputFrequency	INTEGER	Read-Only	Input frequency 3 (0 (fixed)*)
33.1.3.3.1.3.1	upsInputVoltage	INTEGER	Read-Only	Input voltage 1 (unit: 1V)
33.1.3.3.1.3.2	upsInputVoltage	INTEGER	Read-Only	Input voltage 2 (0 (fixed)*)
33.1.3.3.1.3.3	upsInputVoltage	INTEGER	Read-Only	Input voltage 3 (0 (fixed)*)
33.1.3.3.1.4.1	upsInputCurrent	INTEGER	Read-Only	Input current 1 (0 (fixed)*)
33.1.3.3.1.4.2	upsInputCurrent	INTEGER	Read-Only	Input current 2 (0 (fixed)*)
33.1.3.3.1.4.3	upsInputCurrent	INTEGER	Read-Only	Input current 3 (0 (fixed)*)
33.1.3.3.1.5.1	upsInputTruePower	INTEGER	Read-Only	Input power 1 (0 (fixed)*)
33.1.3.3.1.5.2	upsInputTruePower	INTEGER	Read-Only	Input power 2 (0 (fixed)*)
33.1.3.3.1.5.3	upsInputTruePower	INTEGER	Read-Only	Input power 3 (0 (fixed)*)

* "0 (fixed)" also means an unsupported access.

Object-id	Name	Data Type	Access	Description
33.1.4.1	upsOutputSource	INTEGER	Read-Only	Status 3 = Normal 4 = Bypass 5 = Battery 7 = others
33.1.4.2	upsOutputFrequency	INTEGER	Read-Only	Output frequency (unit: 0.1Hz)
33.1.4.3	upsOutputNumLines	INTEGER	Read-Only	3 (fixed)
33.1.4.4.1.1	upsOutputLineIndex	INTEGER	Unsupported	Unsupported
33.1.4.4.1.2.1	upsOutputVoltage	INTEGER	Read-Only	Output voltage 1 (unit: 1V)
33.1.4.4.1.2.2	upsOutputVoltage	INTEGER	Read-Only	Output voltage 2 (unit: 1V)
33.1.4.4.1.2.3	upsOutputVoltage	INTEGER	Read-Only	Output voltage 3 (unit: 1V)
33.1.4.4.1.3.1	upsOutputCurrent	INTEGER	Read-Only	Output current 1 (unit: 0.1A)
33.1.4.4.1.3.2	upsOutputCurrent	INTEGER	Read-Only	Output current 2 (unit: 0.1A)
33.1.4.4.1.3.3	upsOutputCurrent	INTEGER	Read-Only	Output current 3 (unit: 0.1A)
33.1.4.4.1.4.1	upsOutputPower	INTEGER	Read-Only	Output Power 1 (unit: 0.1W)
33.1.4.4.1.4.2	upsOutputPower	INTEGER	Read-Only	Output Power 2 (unit: 0.1W)
33.1.4.4.1.4.3	upsOutputPower	INTEGER	Read-Only	Output Power 3 (unit: 0.1W)
33.1.4.4.1.5.1	upsOutputPercentLoad	INTEGER	Read-Only	Load per rated output 1 (unit: 1%)
33.1.4.4.1.5.2	upsOutputPercentLoad	INTEGER	Read-Only	Load per rated output 2 (unit: 1%)
33.1.4.4.1.5.3	upsOutputPercentLoad	INTEGER	Read-Only	Load per rated output 3 (unit: 1%)
33.1.5.1	upsBypassFrequency	INTEGER	Read-Only	Bypass frequency (unit: 0.1Hz)
33.1.5.2	upsBypassNumLines	INTEGER	Read-Only	3 (fixed)
33.1.5.3.1.1	upsBypassLineIndex	INTEGER	Unsupported	Unsupported
33.1.5.3.1.2.1	upsBypassVoltage	INTEGER	Read-Only	Bypass voltage 1 (unit: 1V)
33.1.5.3.1.2.2	upsBypassVoltage	INTEGER	Read-Only	Bypass voltage 2 (unit: 1V)
33.1.5.3.1.2.3	upsBypassVoltage	INTEGER	Read-Only	Bypass voltage 3 (unit: 1V)
33.1.5.3.1.3.1	upsBypassCurrent	INTEGER	Read-Only	Bypass current 1 (unit: 0.1A)
33.1.5.3.1.3.2	upsBypassCurrent	INTEGER	Read-Only	Bypass current 2 (unit: 0.1A)
33.1.5.3.1.3.3	upsBypassCurrent	INTEGER	Read-Only	Bypass current 3 (unit: 0.1A)
33.1.5.3.1.4.1	upsBypassPower	INTEGER	Read-Only	Bypass Power 1 (unit: 0.1W)
33.1.5.3.1.4.2	upsBypassPower	INTEGER	Read-Only	Bypass power 2 (0 (fixed)*)
33.1.5.3.1.4.3	upsBypassPower	INTEGER	Read-Only	Bypass power 3 (0 (fixed)*)
33.1.6.1	upsAlarmPresent	Gauge32	Read-Only	Number of alarms
33.1.6.2.1.1	upsAlarmId	INTEGER	Unsupported	Unsupported
33.1.6.2.1.2.N	upsAlarmDescr	OBJECT IDENTIFIER	Read-Only	Alarm description N: alarm ID
33.1.6.2.1.3.N	upsAlarmTime	Time Ticks	Read-Only	Alarm time N: alarm ID

* "0 (fixed)" also means an unsupported access.

Object-id	Name	Data Type	Access	Description
33.1.7.1	upsTestId	OBJECT IDENTIFIER	Unsupported	Unsupported
33.1.7.2	upsTestSpinLock	INTEGER	Unsupported	0 (fixed)*
33.1.7.3	upsTestResultsSummary	INTEGER	Read-Only	0 (fixed)*
33.1.7.4	upsTestResultsDetail	OCTET STRING	Unsupported	Empty string (fixed)
33.1.7.5	upsTestStartTime	Time Ticks	Unsupported	0:00:00.00 (fixed)
33.1.7.6	upsTestElapsedTime	INTEGER	Unsupported	0 (fixed)*
33.1.8.1	upsShutdownType	INTEGER	Read-Only	1 = UPS output off (fixed)
33.1.8.2	upsShutdownAfterDelay	INTEGER	Read-Only	0 (fixed)*
33.1.8.3	upsStartupAfterDelay	INTEGER	Read-Only	0 (fixed)*
33.1.8.4	upsRebootWithDuration	INTEGER	Read-Only	0 (fixed)*
33.1.8.5	upsAutoRestart	INTEGER	Read-Only	2 = off (fixed)
33.1.9.1	upsConfigInputVoltage	INTEGER	Read-Only	Rated input voltage (unit: 1V)
33.1.9.2	upsConfigInputFreq	INTEGER	Read-Only	Rated input frequency (unit: 0.1Hz)
33.1.9.3	upsConfigOutputVoltage	INTEGER	Read-Only	Rated output voltage 1 (unit: 1V)
33.1.9.4	upsConfigOutputFreq	INTEGER	Read-Only	Rated output frequency (unit: 0.1Hz)
33.1.9.5	upsConfigOutputVA	INTEGER	Read-Only	Rated output VA (unit: 1VA)
33.1.9.6	upsConfigOutputPower	INTEGER	Read-Only	Rated output power (unit: 1W)
33.1.9.7	upsConfigLowBattTime	INTEGER	Read-Only	0 (fixed)*
33.1.9.8	upsConfigAudibleStatus	INTEGER	Read-Only	1 = disable 2 = enable 3 = mute
33.1.9.9	upsConfigLowVoltageTr ansferPoint	INTEGER	Read-Only	0 (fixed)*
33.1.9.10	upsConfigHighVoltageTr ansferPoint	INTEGER	Read-Only	0 (fixed)*

* "0 (fixed)" also means an unsupported access.

6. 2 SNMP Trap

6. 2. 1 SNMP Trap

SNMP Traps sent on each event are listed below.

(upsTrapAlarmEntryAdded(***) and the detail object of () are described in the following pages.)

No.	Event	SNMP TRAP
1	Temperature abnormal	upsTrapAlarmEntryAdded(upsAlarmTempBad)
2	Temperature abnormal released	upsTrapAlarmEntryRemoved(upsAlarmTempBad)
3	Input abnormal	upsTrapAlarmEntryAdded(upsAlarmInputBad)
4	Input abnormal released	upsTrapAlarmEntryRemoved(upsAlarmInputBad)
5	Output abnormal	upsTrapAlarmEntryAdded(upsAlarmOutputBad)
6	Output abnormal released	upsTrapAlarmEntryRemoved(upsAlarmOutputBad)
7	Overload	upsTrapAlarmEntryAdded(upsAlarmOutputOverload)
8	Overload released	upsTrapAlarmEntryRemoved(upsAlarmOutputOverload)
9	Bypass abnormal	upsTrapAlarmEntryAdded(upsAlarmBypassBad)
10	Bypass abnormal released	upsTrapAlarmEntryRemoved(upsAlarmBypassBad)
11	Charging failure	upsTrapAlarmEntryAdded(upsAlarmChargerFailed)
12	Charging failure released	upsTrapAlarmEntryRemoved(upsAlarmChargerFailed)
13	Fan failure	upsTrapAlarmEntryAdded(upsAlarmFanFailure)
14	Fan failure released	upsTrapAlarmEntryRemoved(upsAlarmFanFailure)
15	General fault	upsTrapAlarmEntryAdded(upsAlarmGeneralFault)
16	General fault released	upsTrapAlarmEntryRemoved(upsAlarmGeneralFault)
17	Low battery	upsTrapAlarmEntryAdded(upsAlarmLowBattery)
18	Low battery released	upsTrapAlarmEntryRemoved(upsAlarmLowBattery)
19	Inverter operation started	The last operation: Battery upsTrapAlarmEntryRemoved(upsAlarmOnBattery) The last operation: Bypass upsTrapAlarmEntryRemoved(upsAlarmOnBypass)
20	Battery operation started	upsTrapOnBattery
21	Bypass operation started	upsTrapAlarmEntryAdded(upsAlarmOnBypass)
22	Battery depleted	upsTrapAlarmEntryAdded(upsAlarmDepletedBattery)
23	Battery depletion released	upsTrapAlarmEntryRemoved(upsAlarmDepletedBattery)
24	Awaiting power	upsTrapAlarmEntryAdded(upsAlarmAwaitingPower)
25	Power recovered	upsTrapAlarmEntryRemoved(upsAlarmAwaitingPower)
26	UPS communication lost	upsTrapAlarmEntryAdded(upsAlarmCommunicationLost)
27	UPS communication recovered	upsTrapAlarmEntryRemoved(upsAlarmCommunicationLost)
28	Web/SNMP board restarted	coldStart
29	Test Trap sent	upsTrapAlarmEntryAdded(upsAlarmGeneralFault)

6. 3 Trap variable-bindings Details

Details for SNMP Trap alarm formats are listed below.

(1) Temperature abnormal

① when occurred

	SNMP Data Item	Date type	Value	Description
variable-bindings	1.3.6.1.2.1.1.3.0 (sysUpTime)	TimeTicks	0~	System Time
	1.3.6.1.6.3.1.1.4.1.0 (snmpTrapOID)	OID	1.3.6.1.2.1.33.2.3 (upsTrapAlarmEntryAdded)	Trap type: UPS alarm occurred
	1.3.6.1.2.1.33.1.6.2.1.1 (upsAlarmId)	INTEGER	1~	Alarm ID
	1.3.6.1.2.1.33.1.6.2.1.2 (upsAlarmDescr)	OID	1.3.6.1.2.1.33.1.6.3.5 (upsAlarmTempBad)	Temperature abnormal

② when released

	SNMP Data Item	Date type	Value	Description
variable-bindings	1.3.6.1.2.1.1.3.0 (sysUpTime)	TimeTicks	0~	System Time
	1.3.6.1.6.3.1.1.4.1.0 (snmpTrapOID)	OID	1.3.6.1.2.1.33.2.4 (upsTrapAlarmEntryRemoved)	Trap type: UPS alarm released
	1.3.6.1.2.1.33.1.6.2.1.1 (upsAlarmId)	INTEGER	1~	Alarm ID
	1.3.6.1.2.1.33.1.6.2.1.2 (upsAlarmDescr)	OID	1.3.6.1.2.1.33.1.6.3.5 (upsAlarmTempBad)	Temperature abnormal

(2) Input abnormal

① when occurred

	SNMP Data Item	Date type	Value	Description
variable-bindings	1.3.6.1.2.1.1.3.0 (sysUpTime)	TimeTicks	0~	System Time
	1.3.6.1.6.3.1.1.4.1.0 (snmpTrapOID)	OID	1.3.6.1.2.1.33.2.3 (upsTrapAlarmEntryAdded)	Trap type: UPS alarm occurred
	1.3.6.1.2.1.33.1.6.2.1.1 (upsAlarmId)	INTEGER	1~	Alarm ID
	1.3.6.1.2.1.33.1.6.2.1.2 (upsAlarmDescr)	OID	1.3.6.1.2.1.33.1.6.3.6 (upsAlarm)	Input abnormal

② when released

	SNMP Data Item	Date type	Value	Description
variable-bindings	1.3.6.1.2.1.1.3.0 (sysUpTime)	TimeTicks	0~	System Time
	1.3.6.1.6.3.1.1.4.1.0 (snmpTrapOID)	OID	1.3.6.1.2.1.33.2.4 (upsTrapAlarmEntryRemoved)	Trap type: UPS alarm released
	1.3.6.1.2.1.33.1.6.2.1.1 (upsAlarmId)	INTEGER	1~	Alarm ID
	1.3.6.1.2.1.33.1.6.2.1.2 (upsAlarmDescr)	OID	1.3.6.1.2.1.33.1.6.3.6 (upsAlarm)	Input abnormal

(3) Output abnormal

① when occurred

	SNMP Data Item	Date type	Value	Description
variable-bindings	1.3.6.1.2.1.1.3.0 (sysUpTime)	TimeTicks	0~	System Time
	1.3.6.1.6.3.1.1.4.1.0 (snmpTrapOID)	OID	1.3.6.1.2.1.33.2.3 (upsTrapAlarmEntryAdded)	Trap type: UPS alarm occurred
	1.3.6.1.2.1.33.1.6.2.1.1 (upsAlarmId)	INTEGER	1~	Alarm ID
	1.3.6.1.2.1.33.1.6.2.1.2 (upsAlarmDescr)	OID	1.3.6.1.2.1.33.1.6.3.7 (upsAlarm)	Output abnormal

② when released

	SNMP DATA ITEM	Date type	Value	Description
variable-bindings	1.3.6.1.2.1.1.3.0 (sysUpTime)	TimeTicks	0~	System Time
	1.3.6.1.6.3.1.1.4.1.0 (snmpTrapOID)	OID	1.3.6.1.2.1.33.2.4 (upsTrapAlarmEntryRemoved)	Trap type: UPS alarm released
	1.3.6.1.2.1.33.1.6.2.1.1 (upsAlarmId)	INTEGER	1~	Alarm ID
	1.3.6.1.2.1.33.1.6.2.1.2 (upsAlarmDescr)	OID	1.3.6.1.2.1.33.1.6.3.7 (upsAlarm)	Output abnormal

(4) Overload

① when occurred

	SNMP DATA ITEM	Date type	Value	Description
variable-bindings	1.3.6.1.2.1.1.3.0 (sysUpTime)	TimeTicks	0~	System Time
	1.3.6.1.6.3.1.1.4.1.0 (snmpTrapOID)	OID	1.3.6.1.2.1.33.2.3 (upsTrapAlarmEntryAdded)	Trap type: UPS alarm occurred
	1.3.6.1.2.1.33.1.6.2.1.1 (upsAlarmId)	INTEGER	1~	Alarm ID
	1.3.6.1.2.1.33.1.6.2.1.2 (upsAlarmDescr)	OID	1.3.6.1.2.1.33.1.6.3.8 (upsAlarm)	Overload

② when released

	SNMP DATA ITEM	Date type	Value	Description
variable-bindings	1.3.6.1.2.1.1.3.0 (sysUpTime)	TimeTicks	0~	System Time
	1.3.6.1.6.3.1.1.4.1.0 (snmpTrapOID)	OID	1.3.6.1.2.1.33.2.4 (upsTrapAlarmEntryRemoved)	Trap type: UPS alarm released
	1.3.6.1.2.1.33.1.6.2.1.1 (upsAlarmId)	INTEGER	1~	Alarm ID
	1.3.6.1.2.1.33.1.6.2.1.2 (upsAlarmDescr)	OID	1.3.6.1.2.1.33.1.6.3.8 (upsAlarm)	Overload

(5) Bypass abnormal
① when occurred

	SNMP DATA ITEM	Date type	Value	Description
variable-bindings	1.3.6.1.2.1.1.3.0 (sysUpTime)	TimeTicks	0~	System Time
	1.3.6.1.6.3.1.1.4.1.0 (snmpTrapOID)	OID	1.3.6.1.2.1.33.2.3 (upsTrapAlarmEntryAdded)	Trap type: UPS alarm occurred
	1.3.6.1.2.1.33.1.6.2.1.1 (upsAlarmId)	INTEGER	1~	Alarm ID
	1.3.6.1.2.1.33.1.6.2.1.2 (upsAlarmDescr)	OID	1.3.6.1.2.1.33.1.6.3.10 (upsAlarm)	Bypass abnormal

② when released

	SNMP DATA ITEM	Date type	Value	Description
variable-bindings	1.3.6.1.2.1.1.3.0 (sysUpTime)	TimeTicks	0~	System Time
	1.3.6.1.6.3.1.1.4.1.0 (snmpTrapOID)	OID	1.3.6.1.2.1.33.2.4 (upsTrapAlarmEntryRemoved)	Trap type: UPS alarm released
	1.3.6.1.2.1.33.1.6.2.1.1 (upsAlarmId)	INTEGER	1~	Alarm ID
	1.3.6.1.2.1.33.1.6.2.1.2 (upsAlarmDescr)	OID	1.3.6.1.2.1.33.1.6.3.10 (upsAlarm)	Bypass abnormal

(6) Charging failure
① when occurred

	SNMP DATA ITEM	Date type	Value	Description
variable-bindings	1.3.6.1.2.1.1.3.0 (sysUpTime)	TimeTicks	0~	System Time
	1.3.6.1.6.3.1.1.4.1.0 (snmpTrapOID)	OID	1.3.6.1.2.1.33.2.3 (upsTrapAlarmEntryAdded)	Trap type: UPS alarm occurred
	1.3.6.1.2.1.33.1.6.2.1.1 (upsAlarmId)	INTEGER	1~	Alarm ID
	1.3.6.1.2.1.33.1.6.2.1.2 (upsAlarmDescr)	OID	1.3.6.1.2.1.33.1.6.3.13 (upsAlarm)	Charging failure

② when released

	SNMP DATA ITEM	Date type	Value	Description
variable-bindings	1.3.6.1.2.1.1.3.0 (sysUpTime)	TimeTicks	0~	System Time
	1.3.6.1.6.3.1.1.4.1.0 (snmpTrapOID)	OID	1.3.6.1.2.1.33.2.4 (upsTrapAlarmEntryRemoved)	Trap type: UPS alarm released
	1.3.6.1.2.1.33.1.6.2.1.1 (upsAlarmId)	INTEGER	1~	Alarm ID
	1.3.6.1.2.1.33.1.6.2.1.2 (upsAlarmDescr)	OID	1.3.6.1.2.1.33.1.6.3.13 (upsAlarm)	Charging failure

(7) Fan fault
① when occurred

	SNMP DATA ITEM	Date type	Value	Description
variable-bindings	1.3.6.1.2.1.1.3.0 (sysUpTime)	TimeTicks	0~	System Time
	1.3.6.1.6.3.1.1.4.1.0 (snmpTrapOID)	OID	1.3.6.1.2.1.33.2.3 (upsTrapAlarmEntryAdded)	Trap type: UPS alarm occurred
	1.3.6.1.2.1.33.1.6.2.1.1 (upsAlarmId)	INTEGER	1~	Alarm ID
	1.3.6.1.2.1.33.1.6.2.1.2 (upsAlarmDescr)	OID	1.3.6.1.2.1.33.1.6.3.16 (upsAlarm)	Fan fault

② when released

	SNMP DATA ITEM	Date type	Value	Description
variable-bindings	1.3.6.1.2.1.1.3.0 (sysUpTime)	TimeTicks	0~	System Time
	1.3.6.1.6.3.1.1.4.1.0 (snmpTrapOID)	OID	1.3.6.1.2.1.33.2.4 (upsTrapAlarmEntryRemoved)	Trap type: UPS alarm released
	1.3.6.1.2.1.33.1.6.2.1.1 (upsAlarmId)	INTEGER	1~	Alarm ID
	1.3.6.1.2.1.33.1.6.2.1.2 (upsAlarmDescr)	OID	1.3.6.1.2.1.33.1.6.3.16 (upsAlarm)	Fan fault

(8) General fault
① when occurred

	SNMP DATA ITEM	Date type	Value	Description
variable-bindings	1.3.6.1.2.1.1.3.0 (sysUpTime)	TimeTicks	0~	System Time
	1.3.6.1.6.3.1.1.4.1.0 (snmpTrapOID)	OID	1.3.6.1.2.1.33.2.3 (upsTrapAlarmEntryAdded)	Trap type: UPS alarm occurred
	1.3.6.1.2.1.33.1.6.2.1.1 (upsAlarmId)	INTEGER	1~	Alarm ID
	1.3.6.1.2.1.33.1.6.2.1.2 (upsAlarmDescr)	OID	1.3.6.1.2.1.33.1.6.3.18 (upsAlarm)	General fault

② when released

	SNMP DATA ITEM	Date type	Value	Description
variable-bindings	1.3.6.1.2.1.1.3.0 (sysUpTime)	TimeTicks	0~	System Time
	1.3.6.1.6.3.1.1.4.1.0 (snmpTrapOID)	OID	1.3.6.1.2.1.33.2.4 (upsTrapAlarmEntryRemoved)	Trap type: UPS alarm released
	1.3.6.1.2.1.33.1.6.2.1.1 (upsAlarmId)	INTEGER	1~	Alarm ID
	1.3.6.1.2.1.33.1.6.2.1.2 (upsAlarmDescr)	OID	1.3.6.1.2.1.33.1.6.3.18 (upsAlarm)	General fault

(9) Low battery
① when occurred

	SNMP DATA ITEM	Date type	Value	Description
variable-bindings	1.3.6.1.2.1.1.3.0 (sysUpTime)	TimeTicks	0~	System Time
	1.3.6.1.6.3.1.1.4.1.0 (snmpTrapOID)	OID	1.3.6.1.2.1.33.2.3 (upsTrapAlarmEntryAdded)	Trap type: UPS alarm occurred
	1.3.6.1.2.1.33.1.6.2.1.1 (upsAlarmId)	INTEGER	1~	Alarm ID
	1.3.6.1.2.1.33.1.6.2.1.2 (upsAlarmDescr)	OID	1.3.6.1.2.1.33.1.6.3.3 (upsAlarm)	Low battery

② when released

	SNMP DATA ITEM	Date type	Value	Description
variable-bindings	1.3.6.1.2.1.1.3.0 (sysUpTime)	TimeTicks	0~	System Time
	1.3.6.1.6.3.1.1.4.1.0 (snmpTrapOID)	OID	1.3.6.1.2.1.33.2.4 (upsTrapAlarmEntryRemoved)	Trap type: UPS alarm released
	1.3.6.1.2.1.33.1.6.2.1.1 (upsAlarmId)	INTEGER	1~	Alarm ID
	1.3.6.1.2.1.33.1.6.2.1.2 (upsAlarmDescr)	OID	1.3.6.1.2.1.33.1.6.3.3 (upsAlarm)	Low battery

(10) Inverter operation started
① The last operation: Battery

	SNMP DATA ITEM	Date type	Value	Description
variable-bindings	1.3.6.1.2.1.1.3.0 (sysUpTime)	TimeTicks	0~	System Time
	1.3.6.1.6.3.1.1.4.1.0 (snmpTrapOID)	OID	1.3.6.1.2.1.33.2.4 (upsTrapAlarmEntryRemoved)	Trap type: UPS alarm released
	1.3.6.1.2.1.33.1.6.2.1.1 (upsAlarmId)	INTEGER	1~	Alarm ID
	1.3.6.1.2.1.33.1.6.2.1.2 (upsAlarmDescr)	OID	1.3.6.1.2.1.33.1.6.3.2 (upsAlarm)	Battery operation

② The last operation: Bypass

	SNMP DATA ITEM	Date type	Value	Description
variable-bindings	1.3.6.1.2.1.1.3.0 (sysUpTime)	TimeTicks	0~	System Time
	1.3.6.1.6.3.1.1.4.1.0 (snmpTrapOID)	OID	1.3.6.1.2.1.33.2.4 (upsTrapAlarmEntryRemoved)	Trap type: UPS alarm released
	1.3.6.1.2.1.33.1.6.2.1.1 (upsAlarmId)	INTEGER	1~	Alarm ID
	1.3.6.1.2.1.33.1.6.2.1.2 (upsAlarmDescr)	OID	1.3.6.1.2.1.33.1.6.3.9 (upsAlarm)	Bypass operation

(11) Battery operation

① Battery operation started or running

Below Trap is sent every minute.

	SNMP DATA ITEM	Date type	Value	Description
variable-bindings	1.3.6.1.2.1.1.3.0 (sysUpTime)	TimeTicks	0~	System Time
	1.3.6.1.6.3.1.1.4.1.0 (snmpTrapOID)	OID	1.3.6.1.2.1.33.2.1 (upsTrapOnBattery)	Trap type: UPS battery operation
	1.3.6.1.2.1.33.1.2.3.0 (upsEstimatedMinutesRemaining)	INTEGER	0	0 (fixed)
	1.3.6.1.2.1.33.1.2.2.0 (upsSecondsOnBattery)	INTEGER	0~	Battery operation time in seconds.
	1.3.6.1.2.1.33.1.9.7.0 (upsConfigLowBattTime)	INTEGER	0	0 (fixed)

(12) Bypass operation

① Bypass operation started

	SNMP DATA ITEM	Date type	Value	Description
variable-bindings	1.3.6.1.2.1.1.3.0 (sysUpTime)	TimeTicks	0~	System Time
	1.3.6.1.6.3.1.1.4.1.0 (snmpTrapOID)	OID	1.3.6.1.2.1.33.2.3 (upsTrapAlarmEntryAdded)	Trap type: UPS alarm occurred
	1.3.6.1.2.1.33.1.6.2.1.1 (upsAlarmId)	INTEGER	1~	Alarm ID
	1.3.6.1.2.1.33.1.6.2.1.2 (upsAlarmDescr)	OID	1.3.6.1.2.1.33.1.6.3.9 (upsAlarm)	Bypass operation

(13) Battery depleted

① when occurred

	SNMP DATA ITEM	Date type	Value	Description
variable-bindings	1.3.6.1.2.1.1.3.0 (sysUpTime)	TimeTicks	0~	System Time
	1.3.6.1.6.3.1.1.4.1.0 (snmpTrapOID)	OID	1.3.6.1.2.1.33.2.3 (upsTrapAlarmEntryAdded)	Trap type: UPS alarm occurred
	1.3.6.1.2.1.33.1.6.2.1.1 (upsAlarmId)	INTEGER	1~	Alarm ID
	1.3.6.1.2.1.33.1.6.2.1.2 (upsAlarmDescr)	OID	1.3.6.1.2.1.33.1.6.3.4 (upsAlarm)	Battery depleted

② when released

	SNMP DATA ITEM	Date type	Value	Description
variable-bindings	1.3.6.1.2.1.1.3.0 (sysUpTime)	TimeTicks	0~	System Time
	1.3.6.1.6.3.1.1.4.1.0 (snmpTrapOID)	OID	1.3.6.1.2.1.33.2.4 (upsTrapAlarmEntryRemoved)	Trap type: UPS alarm released
	1.3.6.1.2.1.33.1.6.2.1.1 (upsAlarmId)	INTEGER	1~	Alarm ID
	1.3.6.1.2.1.33.1.6.2.1.2 (upsAlarmDescr)	OID	1.3.6.1.2.1.33.1.6.3.4 (upsAlarm)	Battery depleted

(14) Awaiting power
① when occurred

	SNMP DATA ITEM	Date type	Value	Description
variable-bindings	1.3.6.1.2.1.1.3.0 (sysUpTime)	TimeTicks	0~	System Time
	1.3.6.1.6.3.1.1.4.1.0 (snmpTrapOID)	OID	1.3.6.1.2.1.33.2.3 (upsTrapAlarmEntryAdded)	Trap type: UPS alarm occurred
	1.3.6.1.2.1.33.1.6.2.1.1 (upsAlarmId)	INTEGER	1~	Alarm ID
	1.3.6.1.2.1.33.1.6.2.1.2 (upsAlarmDescr)	OID	1.3.6.1.2.1.33.1.6.3.21 (upsAlarm)	Awaiting power

② when released (power recovered)

	SNMP DATA ITEM	Date type	Value	Description
variable-bindings	1.3.6.1.2.1.1.3.0 (sysUpTime)	TimeTicks	0~	System Time
	1.3.6.1.6.3.1.1.4.1.0 (snmpTrapOID)	OID	1.3.6.1.2.1.33.2.4 (upsTrapAlarmEntryRemoved)	Trap type: UPS alarm released
	1.3.6.1.2.1.33.1.6.2.1.1 (upsAlarmId)	INTEGER	1~	Alarm ID
	1.3.6.1.2.1.33.1.6.2.1.2 (upsAlarmDescr)	OID	1.3.6.1.2.1.33.1.6.3.21 (upsAlarm)	Awaiting power

(15) UPS communication lost
① when occurred

	SNMP DATA ITEM	Date type	Value	Description
variable-bindings	1.3.6.1.2.1.1.3.0 (sysUpTime)	TimeTicks	0~	System Time
	1.3.6.1.6.3.1.1.4.1.0 (snmpTrapOID)	OID	1.3.6.1.2.1.33.2.3 (upsTrapAlarmEntryAdded)	Trap type: UPS alarm occurred
	1.3.6.1.2.1.33.1.6.2.1.1 (upsAlarmId)	INTEGER	1~	Alarm ID
	1.3.6.1.2.1.33.1.6.2.1.2 (upsAlarmDescr)	OID	1.3.6.1.2.1.33.1.6.3.20 (upsAlarm)	UPS communication lost

② when released (communication recovered)

	SNMP DATA ITEM	Date type	Value	Description
variable-bindings	1.3.6.1.2.1.1.3.0 (sysUpTime)	TimeTicks	0~	System Time
	1.3.6.1.6.3.1.1.4.1.0 (snmpTrapOID)	OID	1.3.6.1.2.1.33.2.4 (upsTrapAlarmEntryRemoved)	Trap type: UPS alarm released
	1.3.6.1.2.1.33.1.6.2.1.1 (upsAlarmId)	INTEGER	1~	Alarm ID
	1.3.6.1.2.1.33.1.6.2.1.2 (upsAlarmDescr)	OID	1.3.6.1.2.1.33.1.6.3.20 (upsAlarm)	UPS communication lost

(16) Web/SNMP board restarted
① Web/SNMP board started / restarted

	SNMP DATA ITEM	Date type	Value	Description
variable-bindings	1.3.6.1.2.1.1.3.0 (sysUpTime)	TimeTicks	0~	System Time
	1.3.6.1.6.3.1.1.4.1.0 (snmpTrapOID)	OID	1.3.6.1.6.3.1.1.5.1 (coldStart)	Trap type:
	1.3.6.1.6.3.1.1.4.3.0 (snmpTrapEnterprise)	OID	1.3.6.1.4.1.8072.3.2.10	-

(17) Test Trap
① Test Trap sent

	SNMP DATA ITEM	Date type	Value	Description
variable-bindings	1.3.6.1.2.1.1.3.0 (sysUpTime)	TimeTicks	0~	System Time
	1.3.6.1.6.3.1.1.4.1.0 (snmpTrapOID)	OID	1.3.6.1.2.1.33.2.3 (upsTrapAlarmEntryAdded)	Trap type: UPS alarm occurred
	1.3.6.1.2.1.33.1.6.2.1.1 (upsAlarmId)	INTEGER	1~	Alarm ID
	1.3.6.1.2.1.33.1.6.2.1.2 (upsAlarmDescr)	OID	1.3.6.1.2.1.33.1.6.3.18 (upsAlarm)	General fault

7. Modbus Slave Function

7. 1 RS-485 connection

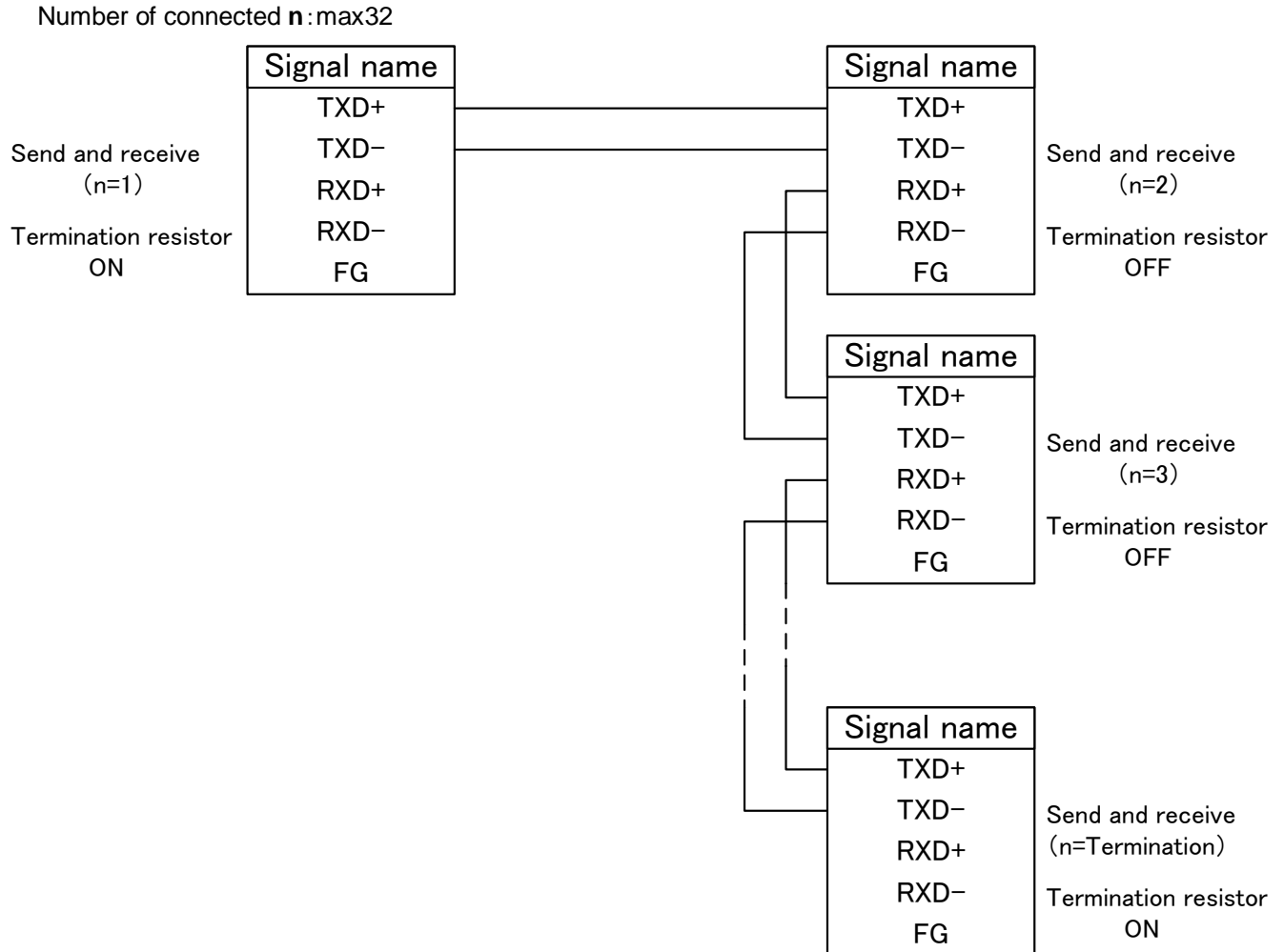

Notes:

- Addresses 300001 (0000) – 300064 (003F) are signed integer representing string data
- Addresses 300081 (0050) – 300183 (00B6) are signed integer data type
- All registers are READ ONLY
- Current Alarm Items are the Failure Code numbers in the Alarm Table for each current alarm. There is no alarm history in the Modbus registers

7. 2 Modbus Device List

Device Number (DEC)	Register Address (HEX)	Item	R/W	Description	Applicable to				
					N002 Firmware: 9.5.0.22				
					N003 Firmware: 24.0.0.0 (see note 1)				
					9900A, 9900B	9900C/CX	9900AEGIS	SUMMIT	9900D
300001-300016	0000-000F	Manufacturer	R	string(32)	*	*	*	*	*
300017-300032	0010-001F	Model	R	string(32)	*	*	*	*	*
300033-300048	0020-002F	Ups Software Version	R	string(32)	*	*	*	*	*
300049-300064	0030-003F	Agent Software Version	R	string(32)	*	*	*	*	*
300081	0050	Nominal Input Voltage	R	V	*	*	*	*	*
300082	0051	Nominal Input Frequency	R	0.1Hz	*	*	*	*	*
300083	0052	Nominal Output Voltage	R	V	*	*	*	*	*
300084	0053	Nominal Output Frequency	R	0.1Hz	*	*	*	*	*
300085	0054	Nominal Output Capacity	R	0.1kVA	*	*	*	*	*
300086	0055	Nominal Output Power	R	0.1kW	*	*	*	*	*
300087	0056	UPS Communication	R	abnormal(0),normal(1)	*	*	*	*	*
300088	0057	Battery Status	R	normal(0),low battery(1),depleted(2)	*	*	*	*	*
300089	0058	Battery Charge	R	Floating(0),Charging(1) Resting(2),Discharging(3)	*	*	*	*	*
300090	0059	Seconds On Battery	R	second	*	*	*	*	*
300092	005B	Estimated Charge Remaining	R	%	*	*	*	*	*
300093	005C	Battery Voltage	R	0.1V	*	*	*	*	*
300094	005D	Battery Current	R	0.1A	*	*	*	*	*
300096	005F	Input Lines Bad	R		*	*	*	*	*

300097	0060	Input Num Lines	R		*	*	*	*	*
300098	0061	Input Frequency	R	0.1Hz	*	*	*	*	*
300099	0062	Input Voltage 1	R	0.1V	*	*	*	*	*
300102	0065	Input Voltage 2	R	0.1V	*	*	*	*	*
300105	0068	Input Voltage 3	R	0.1V	*	*	*	*	*
300108	006B	Output Source	R	inverter(0),battery(1) bypass(2),other(5)	*	*	*	*	*
300109	006C	Output Frequency	R	0.1Hz	*	*	*	*	*
300110	006D	Output Num Lines	R		*	*	*	*	*
300111	006E	Output Voltage 1	R	0.1V	*	*	*	*	*
300112	006F	Output Current 1	R	0.1A	*	*	*	*	*
300113	0070	Output Power 1	R	0.1kW	*	*	*	*	*
300114	0071	Output Percent Load 1	R	%	*	*	*	*	*
300115	0072	Output Voltage 2	R	0.1V	*	*	*	*	*
300116	0073	Output Current 2	R	0.1A	*	*	*	*	*
300117	0074	Synchronous Status	R	inverter off(0) synchronous(1) asynchronous(2)	*	*	*	*	*
300118	0075	Output Percent Load 2	R	%	*	*	*	*	*
300119	0076	Output Voltage 3	R	0.1V	*	*	*	*	*
300120	0077	Output Current 3	R	0.1A	*	*	*	*	*
300122	0079	Output Percent Load 3	R	%	*	*	*	*	*
300127	007E	Load Power Factor	R	0.01	*	*	*	*	*
300128	007F	Bypass Frequency	R	0.1Hz	*	*	*	*	*
300129	0080	Bypass Num Lines	R		*	*	*	*	*
300130	0081	Bypass Voltage 1	R	0.1V	*	*	*	*	*
300131	0082	Bypass Current 1	R	0.1A	*	-	-	-	-

300132	0083	Bypass Power 1	R	0.1kW	*	-	-	-	-
300133	0084	Bypass Voltage 2	R	0.1V	*	*	*	*	*
300134	0085	Bypass Current 2	R	0.1A	*	-	-	-	-
300136	0087	Bypass Voltage 3	R	0.1V	*	*	*	*	*
300137	0088	Bypass Current 3	R	0.1A	*	-	-	-	-
300143	008E	Alarm Temperature	R	non active(0),active(1)	*	*	*	*	*
300144	008F	Alarm Input Bad	R	non active(0),active(1)	*	*	*	*	*
300145	0090	Alarm Output Bad	R	non active(0),active(1)	*	*	*	*	*
300146	0091	Alarm Overload	R	non active(0),active(1)	*	*	*	*	*
300147	0092	Alarm Bypass Bad	R	non active(0),active(1)	*	*	*	*	*
300148	0093	Alarm Output Off	R	non active(0),active(1)	-	*	-	-	-
300150	0095	Alarm Charger Failure	R	non active(0),active(1)	*	-	*	*	-
300152	0097	Alarm Fan Failure	R	non active(0),active(1)	*	-	*	*	-
300154	0099	Alarm General Fault	R	non active(0),active(1)	*	*	*	*	*
300155	009A	Alarm Awaiting Power	R	non active(0),active(1)	*	-	*	*	-
300158	009D	Current Alarm Number	R		*	*	*	*	*
300159	009E	Current Alarm Item 1	R	*Refer to Alarm Flag Table	*	*	*	*	*
300160	009F	Current Alarm Item 2	R	*Refer to Alarm Flag Table	*	*	*	*	*
300161	00A0	Current Alarm Item 3	R	*Refer to Alarm Flag Table	*	*	*	*	*
300162	00A1	Current Alarm Item 4	R	*Refer to Alarm Flag Table	*	*	*	*	*
300163	00A2	Current Alarm Item 5	R	*Refer to Alarm Flag Table	*	*	*	*	*
300164	00A3	Current Alarm Item 6	R	*Refer to Alarm Flag Table	*	*	*	*	*
300165	00A4	Current Alarm Item 7	R	*Refer to Alarm Flag Table	*	*	*	*	*
300166	00A5	Current Alarm Item 8	R	*Refer to Alarm Flag Table	*	*	*	*	*
300167	00A6	Current Alarm Item 9	R	*Refer to Alarm Flag Table	*	*	*	*	*
300168	00A7	Current Alarm Item 10	R	*Refer to Alarm Flag Table	*	*	*	*	*
300169	00A8	Failure Flag 1	R	*Refer to Failure Flag Table	*	*	*	*	*

300170	00A9	Status Flag 1	R	*Refer to Status Flag Table	*	*	*	*	*
300171	00AA	Status Flag 2	R	*Refer to Status Flag Table	*	*	*	*	*
300172	00AB	Alarm Flag 1	R	*Refer to Alarm Flag Table	*	*	*	*	*
300173	00AC	Alarm Flag 2	R	*Refer to Alarm Flag Table	*	*	*	*	*
300174	00AD	Alarm Flag 3	R	*Refer to Alarm Flag Table	*	*	*	*	*
300175	00AE	Alarm Flag 4	R	*Refer to Alarm Flag Table	*	*	*	*	*
300176	00AF	Alarm Flag 5	R	*Refer to Alarm Flag Table	*	*	*	*	*
300177	00B0	Alarm Flag 6	R	*Refer to Alarm Flag Table	*	*	*	*	*
300178	00B1	Alarm Flag 7	R	*Refer to Alarm Flag Table	*	*	*	*	*
300179	00B2	Alarm Flag 8	R	*Refer to Alarm Flag Table	*	*	*	*	*
300180	00B3	Alarm Flag 9	R	*Refer to Alarm Flag Table	*	*	*	*	*
300181	00B4	Alarm Flag 10	R	*Refer to Alarm Flag Table	*	*	*	*	*
300182	00B5	Alarm Flag 11	R	*Refer to Alarm Flag Table	*	*	*	*	*
300183	00B6	Alarm Flag 12	R	*Refer to Alarm Flag Table	*	*	*	*	*
300184	00B7	Operating Module Number	R		-	*	-	-	*
300185	00B8	Module 1 Status Flag	R	16bit *Refer to Module Table	-	*	-	-	*
300186	00B9	Module 2 Status Flag	R	16bit *Refer to Module Table	-	*	-	-	*
300187	00BA	Module 3 Status Flag	R	16bit *Refer to Module Table	-	*	-	-	*
300188	00BB	Module 4 Status Flag	R	16bit *Refer to Module Table	-	*	-	-	*
300189	00BC	Module 5 Status Flag	R	16bit *Refer to Module Table	-	*	-	-	*
300190	00BD	Module 6 Status Flag	R	16bit *Refer to Module Table	-	*	-	-	*
300194	00C1	Module 1 Current U	R	0.1A	-	*	-	-	*
300195	00C2	Module 1 Current V	R	0.1A	-	*	-	-	*
300196	00C3	Module 1 Current W	R	0.1A	-	*	-	-	*
300197	00C4	Module 1 Discharging Current	R	0.1A	-	*	-	-	*
300198	00C5	Module 1 Charging Current	R	0.1A	-	*	-	-	*
300200	00C7	Module 2 Current U	R	0.1A	-	*	-	-	*

300201	00C8	Module 2 Current V	R	0.1A	-	*	-	-	*
300202	00C9	Module 2 Current W	R	0.1A	-	*	-	-	*
300203	00CA	Module 2 Discharging Current	R	0.1A	-	*	-	-	*
300204	00CB	Module 2 Charging Current	R	0.1A	-	*	-	-	*
300206	00CD	Module 3 Current U	R	0.1A	-	*	-	-	*
300207	00CE	Module 3 Current V	R	0.1A	-	*	-	-	*
300208	00CF	Module 3 Current W	R	0.1A	-	*	-	-	*
300209	00D0	Module 3 Discharging Current	R	0.1A	-	*	-	-	*
300210	00D1	Module 3 Charging Current	R	0.1A	-	*	-	-	*
300212	00D3	Module 4 Current U	R	0.1A	-	*	-	-	*
300213	00D4	Module 4 Current V	R	0.1A	-	*	-	-	*
300214	00D5	Module 4 Current W	R	0.1A	-	*	-	-	*
300215	00D6	Module 4 Discharging Current	R	0.1A	-	*	-	-	*
300216	00D7	Module 4 Charging Current	R	0.1A	-	*	-	-	*
300218	00D9	Module 5 Current U	R	0.1A	-	*	-	-	*
300219	00DA	Module 5 Current V	R	0.1A	-	*	-	-	*
300220	00DB	Module 5 Current W	R	0.1A	-	*	-	-	*
300221	00DC	Module 5 Discharging Current	R	0.1A	-	*	-	-	*
300222	00DD	Module 5 Charging Current	R	0.1A	-	*	-	-	*
300224	00DF	Module 6 Current U	R	0.1A	-	*	-	-	*
300225	00E0	Module 6 Current V	R	0.1A	-	*	-	-	*
300226	00E1	Module 6 Current W	R	0.1A	-	*	-	-	*
300227	00E2	Module 6 Discharging Current	R	0.1A	-	*	-	-	*
300228	00E3	Module 6 Charging Current	R	0.1A	-	*	-	-	*
300230	00E5	Module 7 Current U	R	0.1A	-	*	-	-	*
300231	00E6	Module 7 Current V	R	0.1A	-	*	-	-	*
300232	00E7	Module 7 Current W	R	0.1A	-	*	-	-	*

300233	00E8	Module 7 Discharging Current	R	0.1A	-	*	-	-	*
300234	00E9	Module 7 Charging Current	R	0.1A	-	*	-	-	*
300236	00EB	Module 8 Current U	R	0.1A	-	*	-	-	*
300237	00EC	Module 8 Current V	R	0.1A	-	*	-	-	*
300238	00ED	Module 8 Current W	R	0.1A	-	*	-	-	*
300239	00EE	Module 8 Discharging Current	R	0.1A	-	*	-	-	*
300240	00EF	Module 8 Charging Current	R	0.1A	-	*	-	-	*
300242	00F1	Module 9 Current U	R	0.1A	-	*	-	-	*
300243	00F2	Module 9 Current V	R	0.1A	-	*	-	-	*
300244	00F3	Module 9 Current W	R	0.1A	-	*	-	-	*
300245	00F4	Module 9 Discharging Current	R	0.1A	-	*	-	-	*
300246	00F5	Module 9 Charging Current	R	0.1A	-	*	-	-	*

			Supported Items				
Device	bit	Item	9900A, 9900B	9900C/CX	9900AEGIS	SUMMIT	9900D
Failure1	D0	Fatal Fault	*	*	*	*	*
	D1	Minor Fault	*	*	*	*	*
	D2	Alarm	*	*	*	*	*
	D3	spare	*	*	*	*	*
	D4						
	D5						
	D6						
	D7						
	D8	Battery Abnormal	*	*	*	*	*
	D9	Overload	*	*	*	*	*
	D10	Bypass Abnormal	*	*	*	*	*
	D11	Input Abnormal	*	*	*	*	*
	D12	Other Alarm	*	*	*	*	*
	D13						
	D14						
D15							

		9900A, 9900B	9900Aegis	9900C/CX	SUMMIT	9900D
Device	Bit	Item	Item	Item	Item	Item
Status1	D0	CB1 (52R)	CB1 (52R)	CB1 (52R)	CB1 (52R)	CB1
	D1	CB2 (72B)	CB2 (72B)	CB2 (72B)	CB2 (72B)	CB2
	D2					
	D3	52C	52C	52C	52C	52C
	D4	52S	52S	52S	52S	52S
	D5	INVERTER	INVERTER	INVERTER	INVERTER	INVERTER
	D6	CHOPPER	CHOPPER		CHOPPER	
	D7	On INVERTER	On INVERTER	On INVERTER	On INVERTER	On INVERTER
	D8	On BYPASS	On BYPASS	On BYPASS	On BYPASS	On BYPASS
	D9	On BATTERY	On BATTERY	On BATTERY	On BATTERY	On BATTERY
	D10	Synchronous	Synchronous	Synchronous	Synchronous	Synchronous
	D11	Asynchronous	Asynchronous	Asynchronous	Asynchronous	Asynchronous
	D12	Remote	Remote	Remote	Remote	Remote
	D13	Power Demand	Power Demand	Power Demand	Power Demand	Power Demand
	D14	Diamond Synchronous	Diamond Synchronous	Diamond Synchronous	Diamond Synchronous	Diamond Synchronous
D15	Battery Low	Battery Low	Battery Low	Battery Low	Battery Low	

		9900A, 9900B	9900Aegis	9900C/CX	SUMMIT	9900D
Device	Bit	Item	Item	Item	Item	Item
Status2	D0					
	D1	Input Abnormal	Input Abnormal	Input Abnormal	Input Abnormal	Input Abnormal
	D2	Converter	Converter	Converter	Converter	Converter
	D3	External 72BX	External 72BX	External 72BX	External 72BX	External CB2
	D4					
	D5					
	D6					
	D7	52LM	52LM		52LM	
	D8					
	D9					
	D10	Manual Floating	Manual Floating	Manual Floating	Manual Floating	Manual Floating
	D11			Local		Direct operation
	D12					Load power (lead)
	D13					Load power (lag)
	D14					
D15			Test Mode	Test Mode	Test Mode	

		9900A, 9900B			9900Aegis			9900C		
Device	Bit	Failure Code	Display Code	Item	Failure Code	Display Code	Item	Failure Code	Display Code	Item
Alarm 1	D0	0			0			805	UA805	OVERLOAD
	D1	2	UF001	INPUT CIRCUIT ABNORMAL	2	UF001	INPUT CIRCUIT ABNORMAL	806	UA806	INVERTER OVERLOAD
	D2	4	UF002	CONVERTER OVERCURRENT	4	UF002	CONVERTER OVERCURRENT	807	UA807	INVERTER OVERLOAD
	D3	6	UF003	CONVERTER ABNORMAL	6	UF003	CONVERTER ABNORMAL	808	UA808	OVERLOAD
	D4	8	UF006	CONVERTER ABNORMAL	8	UF006	CONVERTER ABNORMAL	810	UA810	OVERLOAD
	D5	10	UF011	CB1 ABNORMAL	10	UF011	CB1 ABNORMAL	812	UA812	BYPS.VOLT.OUT RNG
	D6	12	UF052	CB1 ABNORMAL	12	UF052	CB1 ABNORMAL	813	UA813	BYPS.PHASE ABNL
	D7	14	UF055	CONVERTER ABNORMAL	14			814	UA814	BYPS.FREQ.OUT RNG
	D8	16	UF056	CONVERTER OVERCURRENT	16	UF056	CONVERTER OVERCURRENT	815	UA815	TRANSFER PROHIBITION
	D9	18	UF059	INPUT CIRCUIT ABNORMAL	18	UF059	INPUT CIRCUIT ABNORMAL	817	UA817	EMERG.STOP ACTIV.
	D10	20	UF102	DC OVERVOLTAGE	20	UF102	DC OVERVOLTAGE	821	UA821	REM.BUTTON CLOSE
	D11	22	UF103	DC UNDER VOLTAGE	22	UF103	DC UNDERVOLTAGE	822	UA822	LOC.BUTTON ABNL.
	D12	24	UF108	CHOPPER OVERCURRENT	24	UF108	CHOPPER OVERCURRENT	824	UA824	CB2 OPEN
	D13	26	UF109	DC UNBALANCED	26	UF109	DC UNBALANCED	830	UA830	INTERLOCK SWITCH ON
	D14	28	UF110	ZERO PHASE OVERCURRENT	28	UF110	ZERO PHASE OVERCURRENT	831	UA831	EMERG.BYPS.SW.ON
D15	30	UF111	UPS CONTROL CIRCUIT ERROR	30			833	UA833	52L OPEN	

		9900A, 9900B			9900Aegis			9900C		
Device	Bit	Failure Code	Display Code	Item	Failure Code	Display Code	Item	Failure Code	Display Code	Item
Alarm 2	D0	32	UF112	DC CIRCUIT ABNORMAL	32	UF112	DC CIRCUIT ABNORMAL	834	UA834	BATTERY DEPLETED
	D1	34	UF128	CONTROL POWER SUPPLY ABNORMAL	34	UF128	CONTROL POWER SUPPLY ABNORMAL	835	UA835	TRANS.INHIBITED
	D2	36	UF119	DC GROUND FAULT	36	UF119	DC GROUND FAULT	861	UA861	MODULE ALARM
	D3	38	UF159	DC GROUND FAULT	38	UF159	DC GROUND FAULT	862	UA862	MODULE MINOR FAULT
	D4	40			40			863	UA863	MOD.IN.VOLT.
	D5	42	UF151	BATTERY VOLTAGE ABNORMAL	42	UF151	DC VOLTAGE ABNORMAL	864	UA864	MODULE OVERLOAD
	D6	44	UF152	BATTERY VOLTAGE ABNORMAL	44	UF152	DC VOLTAGE ABNORMAL	865	UA865	MOD.BAT.END
	D7	46			46			866	UA866	BATT.END WA
	D8	48	UF154	CB2 ABNORMAL	48	UF154	CB2 ABNORMAL	890	UA890	EXTERNAL ALARM
	D9	50	UF156	CHG.STOPPED(BATTERY OVERTEMP.)	50	UF156	CHG.STOPPED(BATTERY OVERTEMP.)	6	UF006	CONVERTER ABNORMAL
	D10	52	UF157	BATTERY OVERTEMPERATURE	52	UF157	BATTERY OVERTEMPERATURE	55	UF055	CONVERTER ABNORMAL
	D11	54	UF158	BATTERY LIQUID LOW	54	UF158	BATTERY LIQUID LOW	151	UF151	BAT.VOLTAGE ABNL.
	D12	56	UF160	UPS CONTROL CIRCUIT ERROR	56			152	UF152	BAT.VOLTAGE ABNL.
	D13	58	UF161	CHG.STOPPED(BATTERY VOLT.ABNL.)	58	UF161	CHG.STOPPED(DC VOLT. ABNORMAL)	156	UF156	CHG.STOPPED
	D14	60	UF162	BATTERY ABNORMAL	60	UF162	BATTERY ABNORMAL	157	UF157	BATTERY OVERTEMP.
D15	62	UF163	BATTERY VOLTAGE ABNORMAL	62	UF163	BATTERY VOLTAGE ABNORMAL	158	UF158	BATTERY LIQUID LOW	

		9900A, 9900B			9900Aegis			9900C		
Device	Bit	Failure Code	Display Code	Item	Failure Code	Display Code	Item	Failure Code	Display Code	Item
Alarm 3	D0	64	UF170	VDB SEBSOR ABNORMAL	64	UF170	VDB SENSOR ABNORMAL	161	UF161	CHG.STOPPED
	D1	66	UF171	UPS CONTROL CIRCUIT ERROR	66	UF171	UPS CONTROL CIRCUIT ERROR	162	UF162	BATTERY ABNORMAL
	D2	68	UF172	CHG.STOPPED(DEVICE STATUS)	68	UF172	CHG.STOPPED(DEVICE STATUS)	163	UF163	BAT.VOLTAGE ABNL.
	D3	70			70			172	UF172	INVERTER UV.
	D4	72	UF201	INVERTER OVERVOLTAGE	72	UF201	INVERTER OVERVOLTAGE	202	UF202	CTRL.CIRCUIT ERR.
	D5	74	UF202	INVERTER UNDERVOLTAGE	74	UF202	INVERTER UNDERVOLTAGE	253	UF253	CTRL.CIRCUIT ERR.
	D6	76	UF203	INVERTER OVERCURRENT	76	UF203	INVERTER OVERCURRENT	254	UF254	O/P VOLTAGE ABNL.
	D7	78	UF204	OUTPUT CIRCUIT ABNORMAL	78	UF204	OUTPUT CIRCUIT ABNORMAL	256	UF256	LOAD ABNORMAL
	D8	80	UF206	UPS CONTROL CIRCUIT ERROR	80	UF206	UPS CONTROL CIRCUIT ERROR	258	UF258	CTRL.CIRCUIT ERR.
	D9	82	UF207	ZERO PHASE OVERCURRENT	82	UF207	ZERO PHASE OVERCURRENT	301	UF301	CTRL.CIRCUIT ERR.
	D10	84	UF208	UPS CONTROL CIRCUIT ERROR	84	UF208	UPS CONTROL CIRCUIT ERROR	302	UF302	CTRL.CIRCUIT ERR.
	D11	86	UF209	52C ABNORMAL	86	UF209	52C ABNORMAL	303	UF303	CTRL.CIRCUIT ERR.
	D12	88	UF210	52C ABNORMAL	88	UF210	52C ABNORMAL	305	UF305	CTRL.CIRCUIT ERR.
	D13	90	UF211	52C ABNORMAL	90	UF211	52C ABNORMAL	306	UF306	CTRL.CIRCUIT ERR.
	D14	92			92			320	UF320	CTRL.CIRCUIT ERR.
D15	94	UF214	COOLING FAN ABNORMAL	94	UF214	COOLING FAN ABNORMAL	321	UF321	CTRL.CIRCUIT ERR.	

		9900A, 9900B			9900Aegis			9900C		
Device	Bit	Failure Code	Display Code	Item	Failure Code	Display Code	Item	Failure Code	Display Code	Item
Alarm 4	D0	96	UF213	OVERTEMPERATURE	96	UF213	OVERTEMPERATURE	322	UF322	CTRL.CIRCUIT ERR.
	D1	98	UF230	ZERO PHASE OVERCURRENT	98	UF230	ZERO PHASE OVERCURRENT	323	UF323	CTRL.CIRCUIT ERR.
	D2	100	UF217	INVERTER OVERVOLTAGE	100	UF217	INVERTER OVERVOLTAGE	324	UF324	CTRL.CIRCUIT ERR.
	D3	102	UF253	UPS CONTROL CIRCUIT ERROR	102	UF253	UPS CONTROL CIRCUIT ERROR	325	UF325	CTRL.CIRCUIT ERR.
	D4	104	UF256	OUTPUT VOLTAGE ABNORMAL	104	UF256	OUTPUT VOLTAGE ABNORMAL	326	UF326	CTRL.CIRCUIT ERR.
	D5	106	UF257	52C ABNORMAL	106	UF257	52C ABNORMAL	327	UF327	CTRL.CIRCUIT ERR.
	D6	108	UF258	LOAD ABNORMAL	108	UF258	LOAD ABNORMAL	340	UF340	MODULE MAJOR FAULT
	D7	110	UF259	ANOTHER UPS ABNORMAL	110	UF259	ANOTHER UPS ABNORMAL	341	UF341	#1 MAJOR FAULT
	D8	112			112			342	UF342	#2 MAJOR FAULT
	D9	114	UF301	UPS CONTROL CIRCUIT ERROR	114	UF301	UPS CONTROL CIRCUIT ERROR	343	UF343	#3 MAJOR FAULT
	D10	116	UF302	UPS CONTROL CIRCUIT ERROR	116	UF302	UPS CONTROL CIRCUIT ERROR	344	UF344	#4 MAJOR FAULT
	D11	118	UF303	UPS CONTROL CIRCUIT ERROR	118	UF303	UPS CONTROL CIRCUIT ERROR	349	UF349	MODULE MAJOR FAULT
	D12	120	UF323	UPS CONTROL CIRCUIT ERROR	120	UF323	UPS CONTROL CIRCUIT ERROR	353	UF353	EXTERNAL I/F PCB ABNORMAL
	D13	122	UF305	UPS CONTROL CIRCUIT ERROR	122	UF305	UPS CONTROL CIRCUIT ERROR	371	UF371	CTRL.CIRCUIT ERR.
	D14	124	UF306	UPS CONTROL CIRCUIT ERROR	124	UF306	UPS CONTROL CIRCUIT ERROR	372	UF372	CTRL.CIRCUIT ERR.
D15	126	UF309	INVERTER VOLTAGE ABNORMAL	126	UF309	INVERTER VOLTAGE ABNORMAL	374	UF374	CTRL.CIRCUIT ERR.	

		9900A, 9900B			9900Aegis			9900C		
Device	Bit	Failure Code	Display Code	Item	Failure Code	Display Code	Item	Failure Code	Display Code	Item
Alarm 5	D0	128	UF310	CONTROL POWER SUPPLY ABNORMAL	128	UF310	CONTROL POWER SUPPLY ABNORMAL	375	UF375	CTRL.CIRCUIT ERR.
	D1	130	UF320	UPS CONTROL CIRCUIT ERROR	130	UF320	UPS CONTROL CIRCUIT ERROR	376	UF376	CTRL.CIRCUIT ERR.
	D2	132	UF331	UPS CONTROL CIRCUIT ERROR	132	UF331	UPS CONTROL CIRCUIT ERROR	377	UF377	CTRL.CIRCUIT ERR.
	D3	134	UF332	UPS CONTROL CIRCUIT ERROR	134	UF332	UPS CONTROL CIRCUIT ERROR	378	UF378	CTRL.CIRCUIT ERR.
	D4	136	UF333	UPS CONTROL CIRCUIT ERROR	136	UF333	UPS CONTROL CIRCUIT ERROR	381	UF381	CTRL.CIRCUIT ERR.
	D5	138	UF334	UPS CONTROL CIRCUIT ERROR	138	UF334	UPS CONTROL CIRCUIT ERROR	382	UF382	CTRL.CIRCUIT ERR.
	D6	140	UF352	CONTROL POWER SUPPLY ABNORMAL	140	UF352	CONTROL POWER SUPPLY ABNORMAL	383	UF383	CTRL.CIRCUIT ERR.
	D7	142	UF363	UPS CONTROL CIRCUIT ERROR	142	UF363	UPS CONTROL CIRCUIT ERROR	384	UF384	CTRL.CIRCUIT ERR.
	D8	144	UF372	UPS CONTROL CIRCUIT ERROR	144	UF372	UPS CONTROL CIRCUIT ERROR	385	UF385	CTRL.CIRCUIT ERR.
	D9	146	UF374	UPS CONTROL CIRCUIT ERROR	146	UF374	UPS CONTROL CIRCUIT ERROR	401	UF401	52S ABNORMAL
	D10	148	UF375	UPS CONTROL CIRCUIT ERROR	148	UF375	UPS CONTROL CIRCUIT ERROR	402	UF402	52S ABNORMAL
	D11	150	UF376	UPS CONTROL CIRCUIT ERROR	150	UF376	UPS CONTROL CIRCUIT ERROR	420	UF420	52L OPERATION ERR.
	D12	152	UF377	UPS CONTROL CIRCUIT ERROR	152	UF377	UPS CONTROL CIRCUIT ERROR	451	UF451	52S ABNORMAL
	D13	154	UF378	UPS CONTROL CIRCUIT ERROR	154	UF378	UPS CONTROL CIRCUIT ERROR	452	UF452	CB3 ABNORMAL
	D14	156	UF379	UPS CONTROL CIRCUIT ERROR	156	UF379	UPS CONTROL CIRCUIT ERROR			
D15	158	UF371	UPS CONTROL CIRCUIT ERROR	158	UF371	UPS CONTROL CIRCUIT ERROR				

		9900A, 9900B			9900Aegis			9900C		
Device	Bit	Failure Code	Display Code	Item	Failure Code	Display Code	Item	Failure Code	Display Code	Item
Alarm 6	D0	160	UF401	52S ABNORMAL	160	UF401	52S ABNORMAL			
	D1	162	UF402	52S ABNORMAL	162	UF402	52S ABNORMAL			
	D2	164	UF420	52L OPERATION ERROR	164	UF420	52L OPERATION ERROR			
	D3	166			166					
	D4	168	UF451	52S ABNORMAL	168	UF451	52S ABNORMAL			
	D5	170	UF452	CB3 ABNORMAL	170	UF452	CB3 ABNORMAL			
	D6	172			172					
	D7	174			174					
	D8	176			176					
	D9	178			178					
	D10	180	UA801	AC INPUT VOLTAGE OUT OF RANGE	180	UA801	AC INPUT VOLTAGE OUT OF RANGE			
	D11	182	UA802	AC INPUT FREQUENCY OUT OF RANGE	182	UA802	AC INPUT FREQUENCY OUT OF RANGE			
	D12	184	UA803	AC INPUT PHASE ROTATION ERROR	184	UA803	AC INPUT PHASE ROTATION ERROR			
	D13	186	UA804	CONVERTER OPE. PROHIBITION	186	UA804	CONVERTER OPE. PROHIBITION			
	D14	188	UA805	INVERTER OVERLOAD	188	UA805	INVERTER OVERLOAD			
D15	190	UA806	INVERTER OVERLOAD	190	UA806	INVERTER OVERLOAD				

		9900A, 9900B			9900Aegis			9900C		
Device	Bit	Failure Code	Display Code	Item	Failure Code	Display Code	Item	Failure Code	Display Code	Item
Alarm 7	D0	192	UA807	INVERTER OVERLOAD	192	UA807	INVERTER OVERLOAD			
	D1	194	UA808	INVERTER OVERLOAD	194	UA808	INVERTER OVERLOAD			
	D2	196			196					
	D3	198	UA810	INVERTER OVERLOAD	198	UA810	INVERTER OVERLOAD			
	D4	200	UA870	BALANCER OVERLOAD	200	UA870	BALANCER OVERLOAD			
	D5	202	UA812	BYPASS VOLTAGE OUT OF RANGE	202	UA812	BYPASS VOLTAGE OUT OF RANGE			
	D6	204	UA813	BYPASS PHASE ROTATION ERROR	204	UA813	BYPASS PHASE ROTATION ERROR			
	D7	206	UA814	BYPASS FREQUENCY OUT OF RANGE	206	UA814	BYPASS FREQUENCY OUT OF RANGE			
	D8	208	UA815	TRANSFER INHIBITED	208	UA815	TRANSFER INHIBITED			
	D9	210			210					
	D10	212	UA817	EMERGENCY STOP ACTIVATED	212	UA817	EMERGENCY STOP ACTIVATED			
	D11	214	UA821	TRANSFER INHIBITED	214	UA821	TRANSFER INHIBITED			
	D12	216	UA822	TRANSFER INHIBITED	216	UA822	TRANSFER INHIBITED	868	UA868	CPMC OPEN
	D13	218	UA824	CB2 OPEN	218	UA824	CB2 OPEN	386	UF386	LCD FAULT
	D14	220	UA827	52C OPERATION INHIBITED	220	UA827	52C OPERATION INHIBITED	363	UF363	UPS CONTROL CIRCUIT ERROR
D15	222	UA831	EMERGENCY BYPASS SWITCH ON	222	UA831	EMERGENCY BYPASS SWITCH ON	891	UA891	CHARGER PROHIBITED	

		9900A, 9900B			9900Aegis			9900C		
Device	Bit	Failure Code	Display Code	Item	Failure Code	Display Code	Item	Failure Code	Display Code	Item
Alarm 8	D0	224			224			892	UA892	DISCHARGE PROHIBITED
	D1	226	UA833	52L OPEN	226	UA833	52L OPEN	893	UA893	BATTERY ABNORMAL
	D2	228	UA834	BATTERY DEPLETED/AC OUT STOPPED	228	UA834	BATTERY DEPLETED/AC OUT STOPPED	816	UA816	BYP.VOLT.OUT RNG.2
	D3	230	UA835	TRANSFER INHIBITED	230	UA835	TRANSFER PROHIBITION	373	UF373	STS CONT.CIR.ERR.
	D4	232	UA860	REMOTE BUTTON CLOSE	232	UA860	REMOTE BUTTON ABNORMAL	453	UF453	STS TEMP. ABNOMAL
	D5	234	UA861	LOCAL BUTTON ABNORMAL	234	UA861	LOCAL BUTTON ABNORMAL	345	UF345	#5 MAJOR FAULT
	D6	236	UA890	EXTERNAL ALARM	236	UA890	EXTERNAL ALARM	346	UF346	#6 MAJOR FAULT
	D7	238	UA841	CONVERTER OPE. INHIBITED	238	UA891	CHARGER PROHIBITED	867	UA867	OVERTEMPERATURE
	D8	240	UA828	COOLING FAN ABNORMAL	240	UA828	COOLING FAN ABNORMAL			
	D9	242	UA891	CHARGER PROHIBITED	242	UA892	DISCHARGE PROHIBITED			
	D10	244	UA892	DISCHARGE PROHIBITED	244	UF380	ESTS CONTROL CIRCUIT ERROR			
	D11				246		ESTS CONTROL CIRCUIT ERROR			
	D12				248	UF381				
	D13				250	UF461	OVERTEMPERATURE			
	D14				252	UA871	BYPASS VOLTAGE OUT OF RANGE(2)			
	D15									

		9900A, 9900B			9900Aegis			9900C		
Device	Bit	Failure Code	Display Code	Item	Failure Code	Display Code	Item	Failure Code	Display Code	Item
Alarm 9-12	D0									
	D1									
	D2									
	D3									
	D4									
	D5									
	D6									
	D7									
	D8									
	D9									
	D10									
	D11									
	D12									
	D13									
	D14									
D15										

		SUMMIT			9900D		
Device	Bit	Failure Code	Display Code	Item	Failure Code	Display Code	Item
Alarm 1	D0				805	UA805	OVERLOAD
	D1	2	UF001	INPUT CIRCUIT ABNORMAL	806	UA806	INVERTER OVERLOAD
	D2	4	UF002	CONVERTER OVERCURRENT	807	UA807	INVERTER OVERLOAD
	D3	6	UF003	CONVERTER ABNORMAL	808	UA808	OVERLOAD
	D4	8			810	UA810	OVERLOAD
	D5	10	UF011	CB1 ABNORMAL	812	UA812	BYPS.VOLT.OUT RNG
	D6	12	UF052	CB1 ABNORMAL	813	UA813	BYPS.PHASE ABNL
	D7	14			814	UA814	BYPS.FREQ.OUT RNG
	D8	16	UF056	CONVERTER OVERCURRENT	815	UA815	TRANSFER PROHIBITION
	D9	18	UF059	INPUT CIRCUIT ABNORMAL	817	UA817	EMERG.STOP ACTIV.
	D10	20	UF102	DC OVERVOLTAGE	821	UA821	REM.BUTTON CLOSE
	D11	22	UF103	DC UNDERVOLTAGE	822	UA822	LOC.BUTTON ABNL.
	D12	24	UF108	CHOPPER OVERCURRENT	824	UA824	CB2 OPEN
	D13	26	UF109	DC UNBALANCED	830	UA830	INTERLOCK SWITCH ON
	D14	28	UF110	ZERO PHASE OVERCURRENT	831	UA831	EMERG.BYPS.SW.ON
	D15	30			833	UA833	52L OPEN

		SUMMIT			9900D		
Device	Bit	Failure Code	Display Code	Item	Failure Code	Display Code	Item
Alarm 2	D0	32	UF112	DC CIRCUIT ABNORMAL	834	UA834	BATTERY DEPLETED
	D1	34	UF128	CONTROL POWER SUPPLY ABNORMAL	835	UA835	TRANS.INHIBITED
	D2	36	UF119	DC GROUND FAULT	861	UA861	MODULE ALARM
	D3	38	UF159	DC GROUND FAULT	862	UA862	MODULE MINOR FAULT
	D4	40			863	UA863	MOD.IN.VOLT.
	D5	42	UF151	DC VOLTAGE ABNORMAL	864	UA864	MODULE OVERLOAD
	D6	44	UF152	DC VOLTAGE ABNORMAL	865	UA865	MOD.BAT.END
	D7	46			866	UA866	BATT.END WA
	D8	48	UF154	CB2 ABNORMAL	890	UA890	EXTERNAL ALARM
	D9	50	UF156	CHG.STOPPED(BATTERYOVERTEMP.)	6	UF006	CONVERTER ABNORMAL
	D10	52	UF157	BATTERY OVERTEMPERATURE	55	UF055	CONVERTER ABNORMAL
	D11	54	UF158	BATTERY LIQUID LOW	151	UF151	BAT.VOLTAGE ABNL.
	D12	56	UF160	UPS CONTROL CIRCUIT ERROR	152	UF152	BAT.VOLTAGE ABNL.
	D13	58	UF161	CHG.STOPPED(DC VOLT. ABNORMAL)	156	UF156	CHG.STOPPED
	D14	60	UF162	BATTERY ABNORMAL	157	UF157	BATTERY OVERTEMP.
D15	62	UF163	BATTERY VOLTAGE ABNORMAL	158	UF158	BATTERY LIQUID LOW	

		SUMMIT			9900D		
Device	Bit	Failure Code	Display Code	Item	Failure Code	Display Code	Item
Alarm 3	D0	64			161	UF161	CHG.STOPPED
	D1	66			162	UF162	BATTERY ABNORMAL
	D2	68	UF172	CHG.STOPPED(DEVICE STATUS)	163	UF163	BAT.VOLTAGE ABNL.
	D3	70					
	D4	72	UF201	INVERTER OVERVOLTAGE	202	UF202	INVERTER UV.
	D5	74	UF202	INVERTER UNDERVOLTAGE	253	UF253	CTRL.CIRCUIT ERR.
	D6	76	UF203	INVERTER OVERCURRENT	254	UF254	CTRL.CIRCUIT ERR.
	D7	78	UF204	OUTPUT CIRCUIT ABNORMAL	256	UF256	O/P VOLTAGE ABNL.
	D8	80	UF206	UPS CONTROL CIRCUIT ERROR	258	UF258	LOAD ABNORMAL
	D9	82	UF207	ZERO PHASE OVERCURRENT	301	UF301	CTRL.CIRCUIT ERR.
	D10	84	UF208	UPS CONTROL CIRCUIT ERROR	302	UF302	CTRL.CIRCUIT ERR.
	D11	86	UF209	52C ABNORMAL	303	UF303	CTRL.CIRCUIT ERR.
	D12	88	UF210	52C ABNORMAL	305	UF305	CTRL.CIRCUIT ERR.
	D13	90	UF211	52C ABNORMAL	306	UF306	CTRL.CIRCUIT ERR.
	D14	92			320	UF320	CTRL.CIRCUIT ERR.
D15	94	UF214	COOLING FAN ABNORMAL	321	UF321	CTRL.CIRCUIT ERR.	

		SUMMIT			9900D		
Device	Bit	Failure Code	Display Code	Item	Failure Code	Display Code	Item
Alarm 4	D0	96	UF213	OVERTEMPERATURE	322	UF322	CTRL.CIRCUIT ERR.
	D1	98	UF230	ZERO PHASE OVERCURRENT	323	UF323	CTRL.CIRCUIT ERR.
	D2	100	UF217	INVERTER OVERVOLTAGE	324	UF324	CTRL.CIRCUIT ERR.
	D3	102	UF253	UPS CONTROL CIRCUIT ERROR	325	UF325	CTRL.CIRCUIT ERR.
	D4	104	UF256	OUTPUT VOLTAGE ABNORMAL	326	UF326	CTRL.CIRCUIT ERR.
	D5	106	UF257	52C ABNORMAL	327	UF327	CTRL.CIRCUIT ERR.
	D6	108	UF258	LOAD ABNORMAL	340	UF340	MODULE MAJOR FAULT
	D7	110	UF259	ANOTHER UPS ABNORMAL	341	UF341	#1 MAJOR FAULT
	D8	112			342	UF342	#2 MAJOR FAULT
	D9	114	UF301	UPS CONTROL CIRCUIT ERROR	343	UF343	#3 MAJOR FAULT
	D10	116	UF302	UPS CONTROL CIRCUIT ERROR	344	UF344	#4 MAJOR FAULT
	D11	118	UF303	UPS CONTROL CIRCUIT ERROR	349	UF349	MODULE MAJOR FAULT
	D12	120	UF323	UPS CONTROL CIRCUIT ERROR	353	UF353	EXTERNAL I/F PCB ABNORMAL
	D13	122	UF305	UPS CONTROL CIRCUIT ERROR	371	UF371	CTRL.CIRCUIT ERR.
	D14	124	UF306	UPS CONTROL CIRCUIT ERROR	372	UF372	CTRL.CIRCUIT ERR.
	D15	126	UF309	INVERTER VOLTAGE ABNORMAL	374	UF374	CTRL.CIRCUIT ERR.

		SUMMIT			9900D		
Device	Bit	Failure Code	Display Code	Item	Failure Code	Display Code	Item
Alarm 5	D0	128	UF310	CONTROL POWER SUPPLY ABNORMAL	375	UF375	CTRL.CIRCUIT ERR.
	D1	130	UF320	UPS CONTROL CIRCUIT ERROR	376	UF376	CTRL.CIRCUIT ERR.
	D2	132	UF331	UPS CONTROL CIRCUIT ERROR	377	UF377	CTRL.CIRCUIT ERR.
	D3	134	UF332	UPS CONTROL CIRCUIT ERROR	378	UF378	CTRL.CIRCUIT ERR.
	D4	136	UF333	UPS CONTROL CIRCUIT ERROR	381	UF381	CTRL.CIRCUIT ERR.
	D5	138	UF334	UPS CONTROL CIRCUIT ERROR	382	UF382	CTRL.CIRCUIT ERR.
	D6	140	UF352	CONTROL POWER SUPPLY ABNORMAL	383	UF383	CTRL.CIRCUIT ERR.
	D7	142	UF363	UPS CONTROL CIRCUIT ERROR	384	UF384	CTRL.CIRCUIT ERR.
	D8	144	UF372	UPS CONTROL CIRCUIT ERROR	385	UF385	CTRL.CIRCUIT ERR.
	D9	146	UF374	UPS CONTROL CIRCUIT ERROR	401	UF401	52S ABNORMAL
	D10	148	UF375	UPS CONTROL CIRCUIT ERROR	402	UF402	52S ABNORMAL
	D11	150	UF376	UPS CONTROL CIRCUIT ERROR	420	UF420	52L OPERATION ERR.
	D12	152	UF377	UPS CONTROL CIRCUIT ERROR	451	UF451	52S ABNORMAL
	D13	154	UF378	UPS CONTROL CIRCUIT ERROR	452	UF452	CB3 ABNORMAL
	D14	156	UF379	UPS CONTROL CIRCUIT ERROR			
	D15	158	UF371	UPS CONTROL CIRCUIT ERROR			

		SUMMIT			9900D		
Device	Bit	Failure Code	Display Code	Item	Failure Code	Display Code	Item
Alarm 6	D0	160	UF401	52S ABNORMAL			
	D1	162	UF402	52S ABNORMAL			
	D2	164	UF420	52L OPERATION ERROR			
	D3	164					
	D4	168	UF451	52S ABNORMAL			
	D5	170	UF452	CB3 ABNORMAL			
	D6	172					
	D7	174					
	D8	176					
	D9	178					
	D10	180	UA801	AC INPUT VOLTAGE OUT OF RANGE			
	D11	182	UA802	AC INPUT FREQUENCY OUT OF RANGE			
	D12	184	UA803	AC INPUT PHASE ROTATION ERROR			
	D13	186	UA804	CONVERTER OPE. PROHIBITION			
	D14	188	UA805	INVERTER OVERLOAD			
	D15	190	UA806	INVERTER OVERLOAD			

		SUMMIT			9900D		
Device	Bit	Failure Code	Display Code	Item	Failure Code	Display Code	Item
Alarm 7	D0	192	UA807	INVERTER OVERLOAD			
	D1	194	UA808	INVERTER OVERLOAD			
	D2	196					
	D3	198	UA810	INVERTER OVERLOAD			
	D4	200	UA870	BALANCER OVERLOAD			
	D5	202	UA812	BYPASS VOLTAGE OUT OF RANGE			
	D6	204	UA813	BYPASS PHASE ROTATION ERROR			
	D7	206	UA814	BYPASS FREQUENCY OUT OF RANGE			
	D8	208	UA815	TRANSFER INHIBITED			
	D9	210					
	D10	212	UA817	EMERGENCY STOP ACTIVATED			
	D11	214	UA821	TRANSFER INHIBITED			
	D12	216	UA822	TRANSFER INHIBITED	868	UA868	CPMC OPEN
	D13	218	UA824	CB2 OPEN	386	UF386	LCD FAULT
	D14	220	UA827	52C OPERATION INHIBITED	363	UF363	UPS CONTROL CIRCUIT ERROR
	D15	222	UA831	EMERGENCY BYPASS SWITCH ON	891	UA891	CHARGER PROHIBITED

		SUMMIT			9900D		
Device	Bit	Failure Code	Display Code	Item	Failure Code	Display Code	Item
Alarm 8	D0	224			892	UA892	DISCHARGE PROHIBITED
	D1	226	UA833	52L OPEN	893	UA893	BATTERY ABNORMAL
	D2	228	UA834	BATTERY DEPLETED/AC OUT STOPPED	816	UA816	BYP.VOLT.OUT RNG.2
	D3	230	UA835	TRANSFER PROHIBITION	373	UF373	STS CONT.CIR.ERR.
	D4	232	UA860	REMOTE BUTTON ABNORMAL	453	UF453	STS TEMP. ABNOMAL
	D5	234	UA861	LOCAL BUTTON ABNORMAL	345	UF345	#5 MAJOR FAULT
	D6	236	UA890	EXTERNAL ALARM	346	UF346	#6 MAJOR FAULT
	D7	238	UA841	CONVERTER OPE. INHIBITED			
	D8	240	UA828	COOLING FAN ABNORMAL			
	D9	242	UA891	CHARGER PROHIBITED			
	D10	244	UA892	DISCHARGE PROHIBITED			
	D11						
	D12						
	D13						
	D14						
	D15				818	UA818	MODULE STOP

		SUMMIT			9900D		
Device	Bit	Failure Code	Display Code	Item	Failure Code	Display Code	Item
Alarm 9	D0				837	UA837	BATTERY DEPLETED2
	D1				867	UA867	OVERTEMPERATURE
	D2				454	UF454	STS ABNORMAL
	D3				811	UA811	OVERLOAD
	D4						
	D5						
	D6						
	D7						
	D8						
	D9						
	D10						
	D11						
	D12						
	D13						
	D14						
	D15						

		SUMMIT			9900D		
Device	Bit	Failure Code	Display Code	Item	Failure Code	Display Code	Item
Alarm 10-12	D0						
	D1						
	D2						
	D3						
	D4						
	D5						
	D6						
	D7						
	D8						
	D9						
	D10						
	D11						
	D12						
	D13						
	D14						
	D15						

			Supported Items				
Device	bit	Item	9900A, 9900B	9900C/CX	9900AEGIS	SUMMIT	9900D
Module Status Flag 1-6	D0	INVERTER	NOT SUPPORTED NOT MODULAR SYSTEM	*	NOT SUPPORTED NOT MODULAR SYSTEM	NOT SUPPORTED NOT MODULAR SYSTEM	*
	D1	On INVERTER		*			*
	D2	CB2		*			*
	D3	CHOPPER		*			*
	D4	CONVERTER		*			*
	D5						
	D6						
	D7						
	D8	Alarm		*			*
	D9	Minor Fault		*			*
	D10	Fatal Fault		*			*
	D11						
	D12						
	D13						
	D14	52C		*			*
D15	Module Enable	*	*				

8. Technical Support



Mitsubishi Electric Power Products, Inc.

530 Keystone Drive, Warrendale, PA 15086 Phone: (724) 772-2555, Fax: (724) 778-3146